

DISCLAIMER

This publication contains guidance for builders engaged in or interested in green building products and practices for residential design, development and construction. This publication is not intended to be exhaustive and all-inclusive and the enclosed guidelines are not to be considered the only method of green building. These guidelines for green building originate from the collective experience of leading personnel in the green building movement (marketplace), but must, due to the nature of the responsibilities involved, be presented only as a guide for the use of a qualified developer, builder, remodeler, or design professional.

Nothing in this directory should be construed as policy, an endorsement, warranty (express or implied) or guaranty by the National Association of Home Builders (NAHB), the NAHB Research Center (Research Center), or any persons or organizations involved in the creation of this publication, of any technical descriptions, systems, details, requirements, materials, or products.

NAHB, Research Center, and the publication's authors and publishers expressly disclaim any responsibility for any damage arising from the use, application, or reliance on the recommendations and information contained herein.

COPYRIGHT

COPYRIGHT © 2006, by NATIONAL ASSOCIATION OF HOME BUILDERS, All Rights Reserved

No part of this publication may be reproduced, stored in a retrieval system, or transmitted in any form by any means, electronic, mechanical, photocopying, recording, or otherwise without the prior written consent of the National Association of Home Builders. The green home building guidelines provided as Part One of this document are for the intended use of home builders and home builder associations, which agree to treat the guidelines as proprietary.



ACKNOWLEDGMENTS

NAHB would like to thank the following individuals and organizations for contributing to this project.

These guidelines could not have become a reality without the time and effort of numerous people. For example, input from the Stakeholder Group provided the necessary information to modify and finalize the guidelines. These organizations and individuals helped move green home building techniques and technologies further into mainstream home building.

NAHB ADVISORY GROUP

Lee Kitson

Frank Thompson

Ray Tonjes

Stakeholder Group Members

Name	Organization	Name	Organization
Glenn Acomb	American Society of Landscape Architects	Helen English	Sustainable Buildings Industry Council
Karim Amrane	Air-Conditioning and Refrigeration Institute	John Fantauzzi	Radiant Panel Association
Ray Arnold	Copper Development Association	Tom Farkas	Edison Electric Institute
Erv Bales	NJ Institute of Technology	Anthony Floyd	City of Scottsdale
Ted Bardacke	Global Green USA	Bill Freeman	Resilient Floor Covering Institute
Allan Bilka, RA	International Code Council	Charles Gale	Metropolitan Water District of Southern California
Brian Binash	Wilshire Homes	Michael Gardner	The Gypsum Association
Ken Bland	American Forest and Paper Association	Larry Gruber	Bielinski Homes
Gregg Borchelt	The Brick Industry Association	Kathleen Guidera	Energy and Environmental Building Association
Frank Borelli	The Vinyl Institute	Glenn Hamer	Solar Energy Industries Association
Karen Childress	WCI Communities, Inc.	Gary Heroux	Composite Panel Association
Richard Church	Plastic Pipe and Fittings Association	Glenn Hourahan	Air Conditioning Contractors of America
Stephen Colley	Metropolitan Partnership for Energy	David Jarmul, PE	Insulated Concrete Form Association
Charles Cottrell	North American Insulation Manufacturers Association	Edward Korczak	National Wood Flooring Association
Jim Dangerfield	Forintek Canada Corp.	Mark Leuthold	Cellulose Insulation Manufacturers Association
James Davenport	National Association of Counties	Vivian Loftness	American Institute of Architects
Michelle Desiderio	Fannie Mae	Ray McGowan	National Fenestration Rating Council (NFRC)
Pete Dinger	American Plastics Council	Richard Morgan	Austin Energy Green Building Program
Matt Dobson	Vinyl Siding Institute		
Paul Eisele	Kitchen Cabinet Manufacturers Association		

Stakeholder Group Members

Name	Organization
Jay Murdoch	National Council of the Housing Industry
Michael Pawlukiewicz	Urban Land Institute
Bob Peoples	Carpet and Rug Institute
Rick Perry	Window and Door Manufacturers Association
Tim Piasky	BIA of Southern California
William Pitman	Greater San Antonio Builders Association
Larry Potts, Jr.	Forest Stewardship Council
Jim Ranfone	American Gas Association
Sam Rashkin	Environmental Protection Agency
Maribeth Rizzuto	Steel Framing Alliance
Jan Rohila	Building Industry Assoc. of WA
Dave Schrock	Denver Home Builder Association
Doug Seiter	Department of Energy
David Shepherd	Portland Cement Association
Steve Sides	National Paint and Coatings Association
Frank Stanonik	Gas Appliance Manufacturers Association
Mark Stypczynski	Adhesive and Sealant Council
Wayne Trusty	Athena Sustainable Materials Institute
Richard Walker	American Architectural Manufacturers Association
Mike Walker	Pulte Homes
Rob Watson	Natural Resources Defense Council
Tom Williamson	APA—The Engineered Wood Association
David Wilson	Residential Energy Services Network
Duane Wolk	Earth Advantage—Portland General Electric
Mary Yager	National Arbor Day Foundation
Richard Zimmerman	AZ Sunshine Publishers, Inc.

Green Home Building Programs and Their Administrators

Name	Green Home Building Program
Nalani Blane	Hawaii Built Green™
Kim Calomino	Built Green™ Colorado
Art Castle	Built Green™ Kitsap
Lindsay Chism	New Mexico Building America Partner Program
Karen Cook	Green Alliance
Nathan Engstrom	WI Green Built Home
Richard Faesy	Vermont Builds Greener
Anthony Floyd	Green Building Program
Jim Hackler	Earth Craft House
Randy Hansell	Earth Advantage™
Joan Kelsch	Green Home Choice
Eric Martin	Green Home Designation
Richard Morgan	Austin Energy Green Building Program
Denis Murray	City of Aspen Efficient Building Program
Tony Novelli	Southern Arizona Green Building Alliance
Kathy Pfeifer	Innovative Building Review Program
Darren Port	NJ Affordable Green Program
Robert Raymer	California Green Builder Program
Jean Richmond-Bowman	I-Built
Robin Rogers	Built Green™ Seattle
Tiffany Speir	Tacoma-Pierce County Built Green™
Dona Stankus	NC HealthyBuilt Homes
Elizabeth Vasatka	Green Points Program
Mary Venables	“GreenStar” Building Incentive Program
Joel White	Built Green™ of SW Washington
Becky Williamson	EcoBUILD
Jeff Witt	Frisco, TX, Green Building Program
Sarah Wolak	Build Green Program of Kansas City



TABLE OF CONTENTS



INTRODUCTION	1
Guiding Principles	1
How Homeowners Can Benefit From Green Building	4
Guidelines Development Process	4
How to Use The Guidelines	7
Section 1 Lot Design, Preparation, and Development	9
1.1 Select the Site	9
1.2 Identify Goals With Your Team	9
1.3 Design the Site	9
1.4 Develop the Site	11
1.5 Innovative Options	11
Section 2 Resource Efficiency	15
2.1 Reduce Quantity of Materials and Waste	15
2.2 Enhance Durability and Reduce Maintenance	15
2.3 Reuse Materials	16
2.4 Use Recycled Content Materials	16
2.5 Recycle Waste Materials During Construction	17
2.6 Use Renewable Materials	17
2.7 Use Resource-Efficient Materials	17
2.8 Innovative Options	17
Section 3 Energy Efficiency	21
3.1 Implement an Integrated and Comprehensive Approach to Energy-Efficient Design of Building Site, Building Envelope, and Mechanical Space Conditioning Systems	21
3.2 Performance Path	21
3.3 Prescriptive Path	22
3.3.5 Renewable Energy/Solar Heating and Cooling	26
3.3.7 Innovative Options	29
Section 4 Water Efficiency	33
4.1 Indoor/Outdoor Water Use	33
4.2 Innovative Options	33
Section 5 Indoor Environmental Quality	37
5.1 Minimize Potential Sources of Pollutants	37
5.2 Manage Potential Pollutants Generated in the Home	37
5.3 Moisture Management (Vapor, Rainwater, Plumbing, HVAC)	38
5.4 Innovative Options	38



Section **6** **Operation, Maintenance, and Homeowner Education** **41**

6.1	Provide Home Manual to Owners/Occupants on the Use and Care of the Home That Must Include All Items Below	41
6.2	Optional Information to Include in the Home Manual	41
6.3	Provide Education to Owners/Occupants in the Use and Care of Their Dwellings	42
6.4	Solid Waste	42
6.5	Innovative Options	42

Section **7** **Global Impact** **45**

7.1	Products	45
7.2	Innovative Options	45

Appendix **A**—**Site Planning and Land Development** **49**

1.0	Identify Goals With Your Team	49
2.0	Select the Site	49
3.0	Design the Site	50
4.0	Develop the Site	52
5.0	Innovative Options	52





The process of green building incorporates environmental considerations into every phase of the home building process. That means that during the design, construction, and operation of a home, energy and water efficiency, lot development, resource efficient building design and materials, indoor environmental quality, homeowner maintenance, and the home's overall impact on the environment are all taken into account.

Now to answer the question, “**Why should we care about green building?**” There are many compelling reasons for changing the way we build and operate homes. Although we cannot avoid affecting the environment when we build a house, green building can work toward minimizing that environmental impact.

These guidelines were designed with the mainstream home builder in mind. We recognize that many home building companies already incorporate some elements of green building into their current practices. However, the purpose of these guidelines is to highlight ways in which a mainstream home builder can effectively and holistically weave environmental concerns into a new home and to provide a tool for local associations to create a green home building program.

At the time these guidelines were created, there were 28 green home building programs in operation throughout the United States. These programs have done a great job of spreading the word about green home building. However, there are numerous other locales that are interested in green home building but have not had the resources to create a program from scratch. These guidelines are intended to serve as a tool kit for home builder associations to create new programs and to help those programs expand and flourish.

GUIDING PRINCIPLES

As noted above, during the process of building a green home, a builder takes numerous considerations into account simultaneously and consciously incorporates

environmental issues into all decisions. These model green home building guidelines consist of a variety of distinct line items that a builder can choose from in creating a green home. For

organizational purposes, we have grouped the line items into overarching sections, or guiding principles. Below are the guiding principles addressed in green home building:

Guiding Principle—LOT DESIGN, PREPARATION, AND DEVELOPMENT

Resource-efficient site design and development practices help reduce the environmental impacts and improve the energy performance of new housing. For instance, site design principles such as saving trees, constructing onsite storm water retention/infiltration features, and orienting houses to maximize passive solar heating and cooling are basic processes used in the design and construction of green homes.

Guiding Principle—RESOURCE EFFICIENCY

Most successful green homes started with the consideration of the environment at the design phase—the time at which material selection occurs. Creating resource-efficient designs and using resource efficient materials can maximize function while optimizing the use of natural resources. For instance, engineered-wood products can help optimize resources by using materials in which





more than 50% more of the log is converted into structural lumber than conventional dimensional lumber.

Resource efficiency is also about reducing job-site waste. Invariably, there are leftover materials

from the construction process. Developing and implementing a construction waste management plan helps to reduce the quantity of landfill material. The average single-family home in the United States, at 2,320 ft² (NAHB, 2003), is estimated to generate between 6,960 and 12,064 lbs. of construction waste. Thus, by creating an effective construction waste management plan and taking advantage of available recycling facilities and markets for recyclable materials, construction waste can be reduced by at least two-thirds, creating potential cost savings for builders and reducing the burden on landfill space.

Lastly, basing the selection of building materials on their environmental impact can be tricky. For instance, a product might be renewable, but on the other hand it takes a relatively great amount of energy to transport the product to a project's job site. One way to compare products is to look at a product's or a home's life-cycle environmental impacts through a process called life-cycle analysis (LCA). An LCA of a building product covers its environmental impacts "cradle to grave" through six basic steps: 1) Raw material acquisition, 2) Product manufacturing process, 3) Home building process, 4) Home maintenance and operation, 5) Home demolition, and 6) Product reuse, recycling, or disposal. There are numerous reasons why building products are not commonly selected via LCAs. One of the issues is the availability of data—there is a lack of data to feed into tools that allow for an LCA on a product or system.

One such tool created by the National Institute of Standards and Technology (NIST) is the Building for Environmental and Economic Sustainability (BEES) software program. BEES has 10 impact categories: acid rain, ecological toxicity, eutrophication, global warming, human toxicity, indoor air quality, ozone depletion, resource depletion, smog, and solid waste. Since information is not available to conduct full LCAs on all

available building products, we have instead included an LCA mind-set in creating the list of line items in the Resource Efficiency section. Our hope is that in the future the prescriptive line items in the guidelines will eventually be replaced with a full LCA approach for the home as a system and the components therein.

Guiding Principle—ENERGY EFFICIENCY

Energy consumption has far-reaching environmental impacts: from the mining of fossil-fuel energy sources to the environmental emissions from burning non-renewable energy sources. And each home consumes energy year after year, meaning that the environmental impacts associated with that use accrue over time. Therefore, energy efficiency is weighted heavily in a green building program.

Energy consumption occurs not only during the operation of a home but also during the construction of a home and, indirectly, in the production of the materials that go into the home. Although the energy used to heat and cool a home over its life far outweighs that to manufacture the materials and construct it, the large number of homes built (currently about 1.85 million per year) renders the energy used during the construction phase significant.

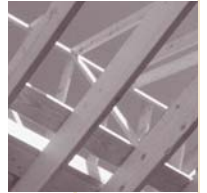

On average, a home built between 1990 and 2001 consumed about 12,800 kWh per year for space and water heating, cooling, and lights and appliances. Where natural gas is used, consumption averages 69,000 cubic feet per household annually. Total energy expenditures during a year cost these homeowners about \$1,600. Energy-efficiency improvements that make a home 20% more efficient—a conservative estimate for many green homes—could significantly reduce a homeowner's annual utility expenses.

No matter what the climate, energy efficiency is considered a priority in most existing green building guidelines/programs. Moreover, as the cost to heat and cool a home becomes more unpredictable, it is advantageous to every homeowner to be "insulated" from inevitable utility bill increases. As with all aspects of these guidelines, the greatest improvements result from a "whole systems" approach. Energy performance does not end with increased R-values, the use of renewable energy, and/or more efficient HVAC equipment. Rather, there needs to be a balance between these features and careful window

selection, building envelope air sealing, duct sealing, and proper placement of air and vapor barriers from foundation to attic to create a truly high-performance, energy-efficient home that is less expensive to operate and more comfortable to live in than a conventionally constructed home.

Guiding Principle—WATER EFFICIENCY

The mean per capita indoor daily water use in today's homes is slightly over 64 gallons. Implementing water conservation measures can reduce usage to fewer than 45 gallons. For this reason, green homes are especially welcomed in areas affected by long- and short-term drought conditions.

The importance of water resources is becoming increasingly recognized, especially in the western third of the country. Choices between sending water to growing urban areas and making water available for irrigation highlight the issues surrounding the scarcity of this valuable resource.

Green homes often conserve water both indoors and out. More efficient water delivery systems indoors and native and drought-resistant landscaping choices outdoors can help prevent unnecessary waste of valuable water resources. Communities can obtain additional benefits when builders effectively use native species in landscaping. Current research and practice have shown that natural processes can be a successful means of filtering and removing contaminants from storm water and wastewater.



Guiding Principle—INDOOR ENVIRONMENTAL QUALITY

Healthy indoor environments attract many people to green building. After energy efficiency, the quality of a home's indoor air is often cited as the most important feature of green homes. Pam Sessions, president of Hedgewood Properties in Atlanta, said during the 2002 National Green Building Conference that the majority of people interested in green homes in the Atlanta market indicated that indoor air quality was their top issue of interest.

An increase in reported allergies and respiratory ailments and the use of chemicals that can off-gas from building materials have contributed to a heightened awareness of the air we breathe inside our homes. Even though there is no authoritative definition of healthy indoor air, there are measures that can mitigate the effects of potential contaminants including controlling the source, diluting the source, and capturing the source through filtration.

Guiding Principle—OPERATION, MAINTENANCE, AND HOMEOWNER EDUCATION

Improper or inadequate maintenance can defeat the designer's and builder's best efforts to create a resource-efficient home. For example, homeowners often fail to change air filters regularly or neglect to operate bath and kitchen exhaust fans to remove moist air. Many homeowners are unaware of the indoor environmental quality impact of using common substances in and around the house such as pesticides, fertilizers, and common cleaning agents. *By providing homeowners with a manual that explains proper operation and maintenance procedures, offers alternatives to toxic cleaning substances and lawn and garden chemicals, and points out water-saving practices, a builder can help assure that the green home that was so carefully built will also be operated in an environmentally responsible manner.*

Guiding Principle—GLOBAL IMPACT

There are some issues related to home building and land development that do not fit neatly into the context of the aforementioned guiding principles. *For these items that are a by-product of home construction, we have added a separate principle—global impact.* One example of an issue having global impact is the selection of paints that contain relatively low or no volatile organic compounds (VOCs). Although the VOC content of paint is often considered for indoor environmental reasons, the vast majority of VOCs are released by the time the paint is dry.

However, the release of VOCs from wet paint helps form ground-level ozone pollution. Therefore, the use of low- or no-VOC paints falls under the global impact principle because the environmental impact of using paints with relatively high VOC levels is greater on the global scale than it is on the indoor environment.

Guiding Principle—SITE PLANNING AND LAND DEVELOPMENT

The process of green home building should not stop at the house. If a builder is also involved in the development of the community, site planning and land development can be part of the process. Therefore, information about low-impact site planning and land development is included in Appendix A. Considering the entire community and existing infrastructure in addition to the individual building(s) can amplify the benefits of green home building. For example, by improving a subdivision's storm water management plan and preserving natural resources through careful design and construction practices, *a builder can influence not only the resource efficiency of each particular house but also the entire subdivision's overall environmental impact.* Low-impact development (LID), which uses various land planning and design practices and technologies to simultaneously conserve and protect natural resources and reduce infrastructure costs, is one way to approach green development.

HOW HOMEOWNERS CAN BENEFIT FROM GREEN BUILDING

The previous section highlighted the environmental benefits of green building practices. However, green building is much more than just reducing a home's environmental footprint. Homeowners can also realize direct benefits by owning a green home. Here are some of the primary benefits that owners of green homes have experienced compared with owners of conventional homes:

- **Lower operating costs**—Homeowners receive less expensive utility bills because of energy and water efficiency measures.
- **Increased comfort**—Green homes have relatively even temperatures throughout the home, with fewer drafts and better humidity control.
- **Improved environmental quality**—By following these guidelines, builders pay extra attention to construction details that control moisture, choose materials that contain fewer chemicals, and design air exchange/filtration systems that can contribute to a healthier indoor environment.

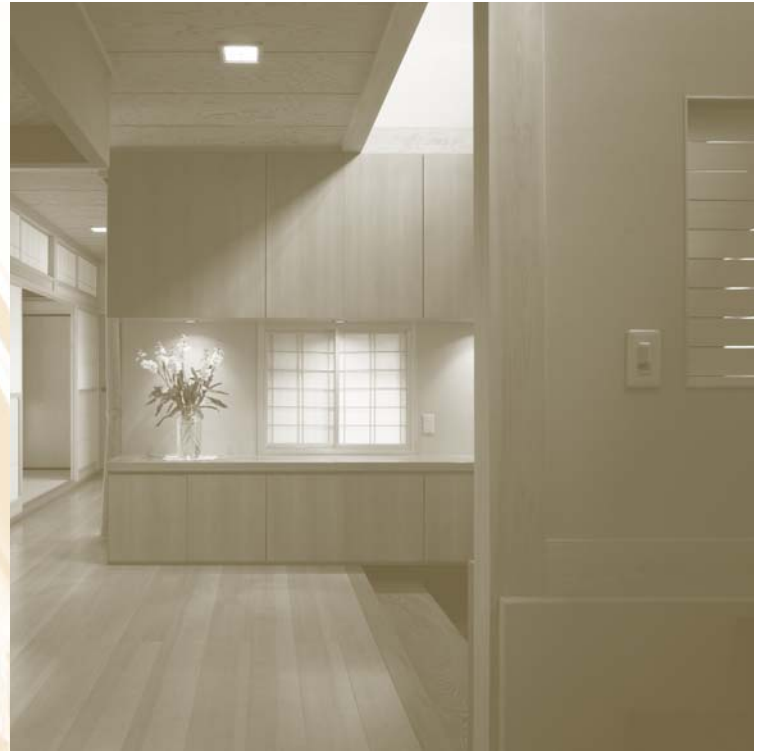

- **Enhanced durability and less maintenance**—Green homes incorporate building materials and construction details that strive to increase the useful life of the individual components and the whole house. Longer-lasting materials not only require fewer resources for replacement but also reduce maintenance and repair costs. Green homes have lawns that require less weeding and watering, building elements that require less maintenance, and more durable building components that reduce the time needed for upkeep.

It is important to note that a builder can do only so much when it comes to how the home will perform. Homeowners play a big role in the house performance and, therefore, should be instructed on how to operate the green home as it was intended.

GUIDELINES DEVELOPMENT PROCESS

The NAHB Model Green Home Building Guidelines were developed through a public process that included the following major steps:

1. An extensive review of the existing local green home builder programs—primarily home builder association programs, but also including several public sector and non-profit programs. All but three of the 28 existing programs are voluntary and market-driven.
2. A review of the voluntary energy-efficiency programs endorsed by NAHB.

3. A review of the leading life-cycle analysis (LCA) tools available for use by residential design and construction professionals in North America (e.g., BEES, ATHENA).
4. Input through an open process from numerous individuals in the NAHB Advisory Group and the Stakeholder Group.
5. Applying certain criteria to each line item in order to give the line items point values.

Each line item in the guidelines has a point value attributed to it. Once the Stakeholder Group members finalized the list of line items for inclusion in the guidelines, the NAHB team looked at each line item through three different lenses: 1) environmental impact, 2) building science and best building practices, and 3) ease of implementation. The team used publicly available information, experiential data, and other data inputs to assign each line item points via these three criteria. Each line item's final point total was calculated by weighting the criteria. Environmental impact received the greatest weight, followed by building science and best building practices, with ease of implementation receiving the least weight.

Environmental Impact—The main purpose of these guidelines is to provide a framework for builders to reduce a home's environmental impact. We assessed how each line item helped make a home more energy efficient, improved indoor environmental quality, and so on. Assigning a value to each line item is an inexact science since all of the necessary data are not available. In addition, some line items had impacts that spanned multiple principles, and, in some cases, the impact was positive for one guiding principle while negative for another. With that as background, the NAHB team took into account all of the above considerations and available data to assess the environmental impact of implementing each line item. Using qualitative and quantitative information, the team assigned value to each line item based on the positive impact to the environment.

Building Science and Best Building Practices—Certain green building practices dramatically affect how a house operates. For example, the sealing of a home's building envelope has an impact on the home's HVAC system. In addition, some measures such as proper flashing details and installation of weather barriers enhance durability, minimize the possibility of indoor environmental problems, and are considered "best building practices." Line



items that help a home perform effectively as a system for the long term were assigned a higher point value.

Ease of Implementation—Some line items are easier to implement than others. The NAHB team compared each line item with current home building practices and estimated how difficult it would be for a builder to implement the line item relative to cost and time. For instance, would it take longer to install a new technology? Would subcontractors need to be educated on the use of a new product? Would a new technology cost more to buy? A line item will have a positive environmental impact only if it is implemented. Line items that were relatively easy to implement (and therefore more likely to be implemented) were assigned a greater point value than the items that are more difficult to implement.

Green Programs and Homes Differ Across the Country

When assigning points to the line items, NAHB assumed the home would be built in Baltimore, which is in Zone 4 of DOE's proposed climate zone map. The map can be viewed at the following web site: www.energycodes.gov/implement/pdfs/color_map_climate_zones_Mar03.pdf

For associations located outside of Zone 4 that are interested in creating a green building program, point values can be customized for some line items most affected by climate conditions. For example, an association in Florida will likely want to increase the point values attributed to installing an energy efficient-air conditioning



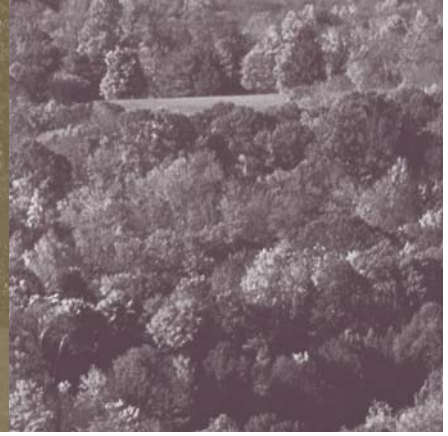

system and decrease the point value associated with installing a high-efficiency heating system. Similarly, in the southwestern United States, associations would probably place higher value on water efficiency measures. A thermometer symbol in the User Guide identifies line items that most likely will see point value changes due to climatic differences across the country.



Additional factors can lead to the decision to alter point values for a certain location, such as the availability of materials, the recycling marketplace, and the existence of rebate programs. A line item's point value is determined by consensus among the members of the green home building program's development committee. This is primarily a qualitative process, and some acknowledgment of the decision-making process should be clearly stated in the program.

Various Levels of Green

Homebuilders differ in their relative knowledge and comfort level with green building concepts. Some builders have been building green for years, while others are being introduced to the ideas for the first time. Recognizing this broad range of knowledge, the NAHB team established various thresholds to delineate different levels of green building effort.

The first step was to identify practices that should be part of any home building project. The first level of green building, Bronze, includes additional line items that in

the end show that a builder paid special attention to a project's environmental impact. The next two levels of green home building, Silver and Gold, include additional line items that place increasingly greater emphasis on the home's environmental impact. The "How to Use the Guidelines" section of this document outlines how to score a home to determine if it meets or exceeds any of the green home building levels noted above.

The Uncertainties of Green Building

It should be noted that although many green building programs have been in existence for 10 years or more, the concept and practice of green building is not clearly defined and straightforward. Many gray areas remain in identifying and quantifying the precise environmental impact for each particular line item. For example, there is very little publicly available information regarding manufacturing processes that document energy consumption, impact on natural resources, or CO₂ emissions for each building material.

In addition, a particular guideline may contain trade-offs and carry with it contradictory characteristics. For example, a recirculating hot water system can help conserve water but may use a relatively large amount of energy in its operation. Although the guidelines in their current form are based on experiential evidence and the latest independent scientific research available, they still may leave many questions unanswered due to the lack of scientific and quantitative data.

Finally, assigning a particular degree of importance to different criteria undoubtedly involves a certain amount of personal or local value judgment. Life-cycle assessment (LCA) tools are beginning to sort out such questions, but the tools still remain in their infancy. Therefore, this set of green home building guidelines should be viewed as a dynamic document that will change and evolve as new information becomes available, improvements are made to existing techniques and technologies, and new research tools are developed.

HOW TO USE THE GUIDELINES

The guidelines are organized by the guiding principles listed above. However, there are two underlying ideas that everyone should keep in mind before undertaking a green home project. First, environmental considerations should be incorporated into the project from the very beginning. It is much harder to weave green home concepts into a project after the house plans are finished. Second, the house should be looked at as a whole as the builder determines which of the green home guideline items to put into the house. For example, making a home's building envelope tighter through air sealing and quality building techniques can affect the way in which the builder designs the home's ventilation system. It is through such a forward-thinking process that builders can gain cost efficiencies.

PART ONE—Green Home-Building Checklist

Part One of these guidelines contains the checklist of line items. Each entry includes the line item title, the point value, and the items that should be provided by the builder to verify that the line item was implemented. The verification column assumes there is a green building program coordinator or other third party. However, the guidelines and point system can be used independently even if a formal green building program does not exist in a particular region.

It is again recommended that a builder first become familiar with the line items prior to designing a home to help introduce concepts that a builder can incorporate into the home's design, construction, and operation.

To help a builder holistically incorporate green building into homes, the NAHB team established different point levels to achieve for each guiding principle at each level of green building. The point system is described below.

POINT SYSTEM

There are three different levels of green building available to builders wishing to use these guidelines to rate their projects—Bronze, Silver, and Gold. At all levels, there are a minimum number of points required for each of the seven guiding principles to assure that all aspects of green building are addressed and that there is a balanced, whole-systems approach. After reaching the thresholds, an additional 100 points must be achieved by implementing any of the remaining line items. The table below outlines the various green building level thresholds.

Points Required for the Three Different Levels of Green Building

	Bronze	Silver	Gold
Lot Design, Preparation, and Development	8	10	12
Resource Efficiency	44	60	77
Energy Efficiency	37	62	100
Water Efficiency	6	13	19
Indoor Environmental Quality	32	54	72
Operation, Maintenance, and Homeowner Education	7	7	9
Global Impact	3	5	6
Additional Points From Sections of Your Choice	100	100	100

** If the home does not have a ducted distribution system for space heating and cooling, deduct 15 points from the number required in the Energy Efficiency section.*

A reduction in the required points for a home without ductwork for the space heating and cooling systems reflects the fact that there are more points available for homes that do have ductwork. It is not intended as an indication of preference for one type of system over another.

To determine point values for each guiding principle, a builder simply adds the points for each line item applied to the home for each guiding principle. Comparing the project's points for the individual guiding principles with the chart above will determine whether the project is deemed a Bronze-, Silver-, or Gold-level green home.



PART TWO — User Guide

Recognizing that some of the line items need more than a one- or two-sentence explanation, the User Guide further explains each concept. For each line item, the User Guide contains an entry with the following subheadings:

Intent—Explains the general reasons for including each line item in the guidelines and the impact that implementing the line item will have on the environment.

Additional Information / How to Implement—Contains text, pictures, and formulas to help facilitate the line item's implementation.

Resources—References to books, web sites, articles, and technical guides for further in-depth information related to the line item. Please note that the URLs were active and current at the time this document was created. With the significant changes occurring on the Internet and in the home building industry products and services markets, location and availability of resources will likely change over time.

As noted earlier, Appendix A provides additional ideas to consider for builders and developers who can effect change at the subdivision level, i.e., multiple home levels.

If a local green home building program does not exist, a builder can use the checklist and User Guide to self-certify a home. However, if a local association has used this document to create a local green building program, the builder can use the checklist and system from that program to show a home's relative green value.

Final Thoughts

We hope you find this tool useful and that it helps further advance green home building practices into mainstream construction. We wish you well in your endeavors and encourage you to share this information with your friends and family, customers, and product suppliers and distributors.





		PTS	HOW TO VERIFY
1.1 SELECT THE SITE			
Select the site to minimize environmental impact.			
1.1.1	Avoid environmentally sensitive areas as identified through site footprinting process or existing third-party data.	7	Any one of the following: <ul style="list-style-type: none"> • Comprehensive plan • Wetland institute • Local jurisdiction's guidelines • Site footprinting process results • Set of site plans
1.1.2	Choose an infill site.	9	
1.1.3	Choose a greyfield site.	7	
1.1.4	Choose an EPA-recognized brownfield.	7	Confirmation from a federal, state, or local brownfields site inventory list or representative that the site is a brownfield
1.2 IDENTIFY GOALS WITH YOUR TEAM			
1.2.1	Establish a knowledgeable team. <ol style="list-style-type: none"> Identify team member roles and how they relate to various phases of green lot design, prep, and development. Create a mission statement that includes the project's goals and objectives. 	6	Written project mission statement, goals, and team member roles
1.3 DESIGN THE SITE			
Minimize environmental impacts; protect, restore, and enhance the natural features and environmental quality of the site (points for each guideline are only rewarded upon implementation of these plans).			
1.3.1	Conserve natural resources. <ol style="list-style-type: none"> Complete a natural resources inventory used to drive and create the site plan. Create a protection and maintenance plan for priority natural resources and areas during construction. See Section 1.4 for guidance in forming the plan. Participate in a natural resources conservation program, e.g., <i>Building With Trees</i>. Provide basic training in tree and other natural resource protection to onsite supervisor. 	6	Pre- and post-development natural resources inventory Protection and maintenance plan Certificate or letter indicating participation in a natural resources conservation program

		PTS	HOW TO VERIFY
1.3.2	Site the home and other built features to optimize solar resource (refer to Energy Efficiency module for guidance on solar resource optimization).	6	House plans
1.3.3	Minimize slope disturbance. <ul style="list-style-type: none"> A. Limit development footprint on steep slopes (slopes greater than or equal to 25%). B. Complete a hydrological/soil stability study for steep slopes, and use this study to guide the design of all structures onsite. C. Align road or extended driveway with natural topography to minimize its grade and reduce cut and fill. D. Reduce long-term erosion effects through the design and implementation of terracing, retaining walls, landscaping, and restabilization techniques. 	5	Hydrological/soil stability study results Topographical map with contour lines
1.3.4	Minimize soil disturbance and erosion. <i>See Section 1.4 for further guidance.</i> <ul style="list-style-type: none"> A. Schedule construction activities to minimize exposed soils. B. Use alternative means to install utilities, such as tunneling instead of trenching, use of smaller equipment, shared trenches or easements, and placement of utilities under streets instead of yards. C. Demarcate limits of clearing and grading. 	6	Sediment and erosion control plans
1.3.5	Manage storm water using low-impact development when possible. <ul style="list-style-type: none"> A. Preserve and use natural water and drainage features. B. Develop and implement storm water management plans that minimize concentrated flows and seek to mimic natural hydrology. C. Minimize impervious surfaces, and use permeable materials for driveways, parking areas, walkways, and patios. 	8	Storm water management plan
1.3.6	Devise landscape plans to limit water and energy demand while preserving or enhancing the natural environment. <ul style="list-style-type: none"> A. Formulate a plan to restore or enhance natural vegetation that is cleared during development. Within this plan, phase landscaping to ensure denuded areas are quickly vegetated. B. Select turf grass and other vegetation that are native or regionally appropriate species. C. Limit turf areas of landscaped area, selecting native and regionally appropriate trees and vegetation in a way that complements the natural setting. D. Group plants with similar watering needs (hydrozoning). E. Specify planting of trees to increase site shading and moderate temperatures (see also Energy Efficiency Guideline 3.4.1.c specifying siting of trees to reduce the energy consumption of the home). F. Design vegetative windbreaks or channels as appropriate to local conditions. 	8	Landscape plan



		PTS	HOW TO VERIFY
	<ul style="list-style-type: none"> G. Require onsite tree trimmings or waste of regionally appropriate trees to be used as protective mulch during construction or as a base for walking trails. H. Establish an integrated pest management plan to minimize chemical use of pesticides and fertilizers. 		
1.3.7	Maintain wildlife habitat.	5	Set of site plans (Extra points) Present a certificate or letter indicating participation in a wildlife conservation program.
1.4 DEVELOP THE SITE			
Minimize environmental intrusion during onsite construction.			
1.4.1	Provide onsite supervision and coordination during clearing, grading, trenching, paving, and installation of utilities to ensure that targeted green development practices are implemented (see 1.3.4).	5	Protection and maintenance plan
1.4.2	<p>Conserve existing onsite vegetation.</p> <ul style="list-style-type: none"> A. Minimize disturbance of and damage to trees and other vegetation designated for protection through installation of fencing and avoidance of trenching, significant changes in grade, and compaction of soil and critical root zones. B. Prepare designated existing trees and vegetation for the impact of construction by pruning, root pruning, fertilizing, and watering. 	5	Protection and maintenance plan and/or set of site plans
1.4.3	<p>Minimize onsite soil disturbance and erosion.</p> <ul style="list-style-type: none"> A. Demarcate limits of clearing and grading. B. Create construction “no disturbance” zones using fencing or flagging to protect vegetation and sensitive areas from construction vehicles, material storage, and washout. C. Install and maintain sediment and erosion controls. D. Stockpile and cover good soil for later use. E. Reduce soil compaction from construction equipment through laying mulch, chipped wood, or plywood sheets. F. Stabilize disturbed areas within the EPA-recommended 14-day period. G. Improve the soil with organic amendments and mulch. 	6	Sediment and erosion control plans
1.5 INNOVATIVE OPTIONS			
Seek to obtain waivers or variances from local development regulations to enhance green building.			
1.5.1	Share driveways or parking.	6	Waiver or variance for the plan
1.5.2	Other (specify).		Waiver or variance for the item(s)



		PTS	HOW TO VERIFY
2.1 REDUCE QUANTITY OF MATERIALS AND WASTE			
2.1.1	Create an efficient floor plan that maintains a home's functionality.	9	House plans
2.1.2	Use advanced framing techniques that reduce the amount of building material while maintaining the structural integrity of the home (see User Guide for examples).	8	House plans
2.1.3	Use building dimensions and layouts that maximize the use of the resources by minimizing material cuts.	6	House plans
2.1.4	Create a detailed framing plan and detailed material takeoffs. Provide an onsite cut list for all framing and sheathing material.	7	Framing plan Cut list
2.1.5	Use building materials that require no additional finish resources to complete application onsite.	4	Product literature Installer, manufacturer, or builder certified
2.1.6	Use pre-cut or pre-assembled building systems or methods.	3 per	Framing plan
A.	Provide a pre-cut (joist) or pre-manufactured (truss) floor and roof framing package—points provided for a flooring or a roof framing package—additional points provided if both packages are used.		
B.	Provide a panelized wall framing system.		
C.	Provide a panelized roof system.		
D.	Provide modular construction for the entire house.	7	
2.1.7	Use a frost-protected shallow foundation (FPSF).	4	
2.2 ENHANCE DURABILITY AND REDUCE MAINTENANCE			
Building design minimizes degradation, and weathering of materials and enhances life expectancy. Features and details are to be specified on architectural plans.			
2.2.1	Provide a covered entry (e.g., awning, covered porch) at exterior doors to prevent water intrusion and subsequent rotting of joists, sills, and finishes.	6	House plans
2.2.2	Use recommended-sized roof overhangs for the climate.	7	House plans
2.2.3	Install perimeter drain for all basement footings sloped to discharge to daylight, dry well, or sump pit.	7	House plans
2.2.4	Install drip edge at eave and gable roof edges.	6	House plans
2.2.5	Install gutter and downspout system to divert water five feet away from foundation and into the overall onsite drainage area.	6	

		PTS	HOW TO VERIFY
2.2.6	Divert surface water from all sides of building. Slope top of backfill to achieve settled slope of at least six inches of fall within 10 feet of the foundation walls.	7	Set of site plans
2.2.7	Install continuous and physical foundation termite barrier in areas where subterranean termite infestation is a problem.	7	
2.2.8	Use termite-resistant materials for walls, floor joists, trusses, exterior decks, etc., in areas known to be termite infested.	7	
2.2.9	Provide a water-resistant barrier (WRB) or a drainage plane system behind the exterior veneer system or the exterior siding.	8	
2.2.10	Install ice flashing at roofs edge.	5	
2.2.11	Install enhanced foundation waterproofing.	7	House plans
2.2.12	Employ and show on plans the following flashing details: A. Around windows and doors B. Valleys C. Deck/house juncture D. Roof/wall junctures, chimneys step flashing E. Drip cap above windows and doors.	9	House plans
2.3 REUSE MATERIALS			
2.3.1	Disassemble existing buildings (deconstruction) instead of demolishing.	6	
2.3.2	Reuse salvaged materials where possible.	5	List of components
2.3.3	Dedicate and provide onsite bins and/or space to facilitate the sorting and reuse of scrap building materials.	6	C & D waste management plan
2.4 USE RECYCLED CONTENT MATERIALS			
2.4.1	Use recycled-content building materials.	3	List of components used
2.5 RECYCLE WASTE MATERIALS DURING CONSTRUCTION			
2.5.1	Develop and implement a construction and demolition (C & D) waste management plan that is posted at job site.	7	Copy of C & D waste management plan
2.5.2	Conduct onsite recycling efforts, e.g., use grinder and apply materials onsite, thus reducing transportation-related costs.	5	Copy of C & D waste management plan including information on what materials are going to be ground for the project
2.5.3	Recycle construction waste offsite, e.g., wood, cardboard, metals, drywall, plastics, asphalt roofing shingles, concrete, block, other.	6	Contractual agreement between the recycling firm and the builder Documentation on materials that have been recycled List of components recycled

		PTS	HOW TO VERIFY
2.6 USE RENEWABLE MATERIALS			
2.6.1	Use materials manufactured from renewable resources or agricultural byproducts such as soy-based insulation, bamboo, or wood-based products	3	List of components used
2.6.2	Use certified wood for wood and wood-based materials and products from all credible third-party-certified sources, including <ul style="list-style-type: none"> A. The Sustainable Forestry Initiative® Program B. The American Tree Farm System® C. The Canadian Standards Association’s Sustainable Forest Management System Standards (CAN/CSA Z809) D. Forest Stewardship Council (FSC) E. Program for the Endorsement of Forest Certification Systems (PEFC), and F. Other such credible programs as they are developed and implemented. 	4	Certification document—points given per component
2.7 USE RESOURCE-EFFICIENT MATERIALS			
2.7.1	Use products that contain fewer resources than traditional products.	3	List of components used
2.8 INNOVATIVE OPTIONS			
2.8.1	Use locally available, indigenous materials.	5	List of components used
2.8.2	Use a life-cycle assessment (LCA) tool to compare the environmental burden of building materials and, based on the analysis, use the most environmentally preferable product for that building component.	8	Provide BEES or ATHENA output to show use of an environmentally preferable product



3.1 IMPLEMENT AN INTEGRATED AND COMPREHENSIVE APPROACH TO ENERGY-EFFICIENT DESIGN OF BUILDING SITE, BUILDING ENVELOPE, AND MECHANICAL SPACE CONDITIONING SYSTEMS

REQUIREMENTS—The home must meet the following conditions listed in 3.1.1 through 3.1.3 below.

The home must also achieve the equivalent of at least 37 points (Bronze level) from the optional guidelines in the performance path (Section 3.2) or the prescriptive path (Section 3.3).

GUIDELINE	PTS	HOW TO VERIFY
3.1.1 Home is equivalent to the IECC 2003 or local energy code, whichever is more stringent. Conformance shall be based on plan analysis using software such as ResCheck or other as approved by green building program administrator.	Req.	ResCheck Analysis (only necessary if the local energy code does not at least meet the IECC 2003 requirements)
3.1.2 Size space heating and cooling system/equipment according to building heating and cooling loads calculated using ANSI/ACCA Manual J 8th Edition or equivalent. Computerized software recognized by ACCA as being in compliance with Manual J 8th Edition may be used.	Req.	Manual J load calculations
3.1.3 Conduct third-party plan review to verify design and compliance with the Energy Efficiency section. When multiple homes of the same model are to be built by the same builder, a representative sample (15%) of homes may be reviewed subject to a sampling protocol.	Req.	Plan review may be completed by Green Building Program administrator, energy program administrators, architect/engineer, consultant, or other party outside of the builder's company and acceptable to the Green Building Program administrator.
3.2 PERFORMANCE PATH		
<p>An energy-efficiency line item with a “(PP)” preceding it is a line item likely to be used to calculate X% above IECC 2003. If a builder chooses to use the performance path—line item 3.2.1—to meet the guideline’s energy-efficiency requirements, then those measures with a “(PP)” cannot be used to obtain the 100 additional points from sections of your choice.</p>		
3.2.1 Home is X% above IECC 2003 A. 15% (Bronze) B. 30% (Silver) C. 40% (Gold)	37 62 100	ResCheck Analysis

GUIDELINE	PTS	HOW TO VERIFY
3.3 PRESCRIPTIVE PATH		
<p>3.3.1 Building envelope</p> <p>(PP)A. Increase effective R-value of building envelope using advanced framing techniques, continuous insulation, and/or, integrated structural insulating system. Measures may include but are not limited to:</p> <ul style="list-style-type: none"> • SIPS*, or • ICFS*, or • Advanced framing, or <ul style="list-style-type: none"> Insulated corners and interior/exterior wall intersections* Insulated headers on exterior walls • Raised heel trusses • Continuous insulation on exterior wall • Continuous insulation on cathedral ceiling <p><i>* This line item also has a resource-efficiency benefit.</i></p>	<p>8</p> <p>8</p> <p>6</p> <p>2</p> <p>4</p> <p>4</p>	<p>Builder certified</p> <p>Approved by local program administrator</p> <p>Builder spec sheet</p>
<p>(PP)B. Incorporate air sealing package to reduce infiltration. <i>(All measures that apply to project must be performed.)</i></p> <ol style="list-style-type: none"> 1. Sill sealer between foundation and sill plate. 2. Caulk bottom plate of exterior walls. 3. Air seal band joist cavities between floors. 4. Ensure air barrier continuity at all framed cavities such as air chases, soffits, coffered or dropped ceilings, and behind tub/shower units on exterior walls. Use either an interior or exterior air barrier as per local practice. 5. Caulk/foam all electrical, plumbing, heating penetrations between floors (including attic, basement, crawl space, and garage) and to exterior 6. Block and seal cantilevered floors and kneewalls. 7. Weatherstrip attic hatches, kneewall doors. 8. Insulate, caulk, or foam between window and door jambs and framing. 9. If installing recessed lights in ceilings adjacent to unconditioned space, use rated, airtight Type IC housings. 10. Caulk/foam HVAC register boots that penetrate the building envelope to subfloor or drywall. 11. If a fireplace is requested, install a sealed combustion gas fireplace or a wood-burning fireplace with gasketed doors. 	<p>10</p>	<p>Builder certified</p>



GUIDELINE	PTS	HOW TO VERIFY																								
(PP)C. Use ENERGY STAR®—rated windows appropriate for local climate.	8	Recommendation for local climate by Energy Efficient Windows Collaborative, www.efficientwindows.org																								
3.3.2 HVAC design, equipment, and installation <ul style="list-style-type: none"> <li data-bbox="285 407 946 470">A. Size, design, and install duct system using ANSI/ACCA Manual D® or equivalent. <li data-bbox="285 478 946 730">B. Design radiant or hydronic space heating systems using industry-approved guidelines, e.g., Guidelines for the Design and Installation of Radiant Panel Heating and Snow/Ice Melting Systems by the Radiant Panel Association, Heat Loss Guide (H-22), by the Hydronics Institute Division of GAMA or accredited design professionals and manufacturer’s recommendations. <li data-bbox="285 739 946 802">C. Use ANSI/ACCA Manual S® or equivalent to select heating and/or cooling equipment. <li data-bbox="285 810 946 1310">D. Verify performance of the heating/cooling system. HVAC contractor to perform the following: <ul style="list-style-type: none"> • Start-up procedure according to manufacturer’s instructions • Refrigerant charge verified by super-heat and/or sub-cooling method • Burner set to fire at nameplate input • Air handler setting/fan speed • Total airflow within 10% of design flow • Total external system static should not exceed equipment capability at rated airflow. <li data-bbox="285 1213 946 1310">E. Use HVAC installer and service technician certified by a nationally or regionally recognized program such as NATE, BPI, RPA, or manufacturers’ training. 	8 8 8 8 6	Manual D calculation Documentation of design or design signed by professional Manual S documentation Certification by HVAC contractor HVAC certification																								
(PP)F. Fuel-fired space heating equipment efficiency (AFUE): <table border="1" data-bbox="269 1444 954 1730" style="width: 100%; border-collapse: collapse;"> <tbody> <tr> <td style="width: 20%;">Gas Furnace</td> <td style="width: 30%;">≥81%</td> <td style="width: 10%;"></td> <td style="width: 40%; text-align: center;">4</td> </tr> <tr> <td></td> <td>≥88% (ENERGY STAR)</td> <td></td> <td style="text-align: center;">6</td> </tr> <tr> <td></td> <td>≥94%</td> <td></td> <td style="text-align: center;">8</td> </tr> <tr> <td>Oil Furnace:</td> <td>≥83%</td> <td></td> <td style="text-align: center;">2</td> </tr> <tr> <td>Gas or Oil Boiler:</td> <td>≥85%% (ENERGY STAR)</td> <td></td> <td style="text-align: center;">2</td> </tr> <tr> <td></td> <td>>90%</td> <td></td> <td style="text-align: center;">6</td> </tr> </tbody> </table> <p data-bbox="269 1747 954 1797"><i>Note: Add three points if Manuals S and D and start-up procedures are followed when one of the space heating units noted above is installed.</i></p>	Gas Furnace	≥81%		4		≥88% (ENERGY STAR)		6		≥94%		8	Oil Furnace:	≥83%		2	Gas or Oil Boiler:	≥85%% (ENERGY STAR)		2		>90%		6		Certification by HVAC contractor
Gas Furnace	≥81%		4																							
	≥88% (ENERGY STAR)		6																							
	≥94%		8																							
Oil Furnace:	≥83%		2																							
Gas or Oil Boiler:	≥85%% (ENERGY STAR)		2																							
	>90%		6																							

GUIDELINE	PTS	HOW TO VERIFY
<p>(PP)G. Heat pump efficiency (cooling mode)</p> <ol style="list-style-type: none"> 1. SEER 11-12* 2. SEER 13-14 3. SEER 15-18 4. SEER 19+ 5. Staged air conditioning equipment <p><i>Note: Split systems must be ARI-tested as a matched set.</i></p> <p><i>*SEER 13 will be federal minimum as of January 2006.</i></p> <p><i>Note: Add three points if Manuals S and D and start-up procedures are followed when one of the ground source heat pumps noted above has been installed. Do not take these points again in 3.3.2.H.</i></p>	<p>4</p> <p>6</p> <p>6</p> <p>7</p> <p>9</p>	<p>Certification by HVAC contractor</p>
<p>(PP)H. Heat pump efficiency (heating mode)</p> <ol style="list-style-type: none"> 7. 2-7.9 HSPF 8. 0-8.9HSPF 9. 0-10.5HSPF >10.5 HSPF <p><i>Note: Split systems must be ARI-tested as a matched set.</i></p>	<p>6</p> <p>7</p> <p>9</p> <p>10</p>	<p>Certification by HVAC contractor</p>
<p>(PP)I. Ground source heat pump installed by a certified geothermal service contractor (cooling mode).</p> <p>EER = 13-14</p> <p>EER = 15-18</p> <p>EER = 19-24</p> <p>EER = >25</p> <p><i>Note: Add three points if Manuals S and D and start-up procedures are followed when one of the ground source heat pumps noted above has been installed. Do not take these points again in 3.3.2.J.</i></p>	<p>5</p> <p>6</p> <p>8</p> <p>10</p>	<p>Certification by HVAC contractor</p> <p>The equipment supplier and the contractor shall furnish, in writing, a “geothermal loop performance guarantee” stating that the heat rejection and absorption of the equipment will not exceed the geothermal loop design submitted and will consistently perform at or above specified efficiencies (taking into account water flow, airflow and entering water temperature).</p>
<p>(PP)J. Ground source heat pump installed by a Certified Geothermal Service Contractor (heating mode).</p> <ol style="list-style-type: none"> 1. COP 2.4 - 2.6 2. COP 2.7 - 2.9 3. COP \geq3.0 	<p>6</p> <p>8</p> <p>10</p>	<p>Certification by HVAC contractor</p>
<p>K. Seal ducts, plenums, and equipment to reduce leakage. Use UL 181 foil tapes and/or mastic.</p>	<p>6</p>	<p>Certification by HVAC contractor</p>



GUIDELINE	PTS	HOW TO VERIFY																																						
<p>L. When installing ductwork:</p> <ol style="list-style-type: none"> 1. No building cavities used as ductwork, e.g., panning joist or stud cavities. 2. Install all heating and cooling ducts and mechanical equipment within the conditioned building envelope. 3. No ductwork installed in exterior walls. 	8	Certification by HVAC contractor																																						
<p>M. Install return ducts or transfer grilles in every room having a door except baths, kitchens, closets, pantries, and laundry rooms.</p>	6	Certification by HVAC contractor																																						
<p>N. Install ENERGY STAR ceiling fans. (Points per fan)</p>	1	Builder certified																																						
<p>O. Install whole-house fan with insulated louvers.</p>	4	Builder certified																																						
<p>P. Install ENERGY STAR-labeled mechanical exhaust in every bathroom ducted to the outside.</p>	8	Builder certified																																						
<p>3.3.3 Water heating design, equipment, and installation</p>																																								
<p>A. Water heater energy factor (EF) equal to or greater than those listed in the following table.</p>	4	Installer certified																																						
<table border="1" style="width: 100%; border-collapse: collapse;"> <thead> <tr> <th colspan="2" style="background-color: #4b4b4b; color: white; text-align: center;">GAS</th> </tr> <tr> <th style="text-align: left;">Size (gallons)</th> <th style="text-align: left;">Energy Factor</th> </tr> </thead> <tbody> <tr><td style="text-align: center;">30</td><td style="text-align: center;">0.64</td></tr> <tr><td style="text-align: center;">40</td><td style="text-align: center;">0.62</td></tr> <tr><td style="text-align: center;">50</td><td style="text-align: center;">0.60</td></tr> <tr><td style="text-align: center;">65</td><td style="text-align: center;">0.58</td></tr> <tr><td style="text-align: center;">75</td><td style="text-align: center;">0.56</td></tr> </tbody> </table> <table border="1" style="width: 100%; border-collapse: collapse;"> <thead> <tr> <th colspan="2" style="background-color: #4b4b4b; color: white; text-align: center;">ELECTRIC</th> </tr> <tr> <th style="text-align: left;">Size (gallons)</th> <th style="text-align: left;">Energy Factor</th> </tr> </thead> <tbody> <tr><td style="text-align: center;">30</td><td style="text-align: center;">0.95</td></tr> <tr><td style="text-align: center;">40</td><td style="text-align: center;">0.94</td></tr> <tr><td style="text-align: center;">50</td><td style="text-align: center;">0.92</td></tr> <tr><td style="text-align: center;">65</td><td style="text-align: center;">0.90</td></tr> <tr><td style="text-align: center;">80</td><td style="text-align: center;">0.88</td></tr> <tr><td style="text-align: center;">100</td><td style="text-align: center;">0.86</td></tr> </tbody> </table> <table border="1" style="width: 100%; border-collapse: collapse;"> <thead> <tr> <th colspan="2" style="background-color: #4b4b4b; color: white; text-align: center;">OIL</th> </tr> <tr> <th style="text-align: left;">Size (gallons)</th> <th style="text-align: left;">Energy Factor</th> </tr> </thead> <tbody> <tr><td style="text-align: center;">30</td><td style="text-align: center;">0.59</td></tr> <tr><td style="text-align: center;">50</td><td style="text-align: center;">0.55</td></tr> </tbody> </table>	GAS		Size (gallons)	Energy Factor	30	0.64	40	0.62	50	0.60	65	0.58	75	0.56	ELECTRIC		Size (gallons)	Energy Factor	30	0.95	40	0.94	50	0.92	65	0.90	80	0.88	100	0.86	OIL		Size (gallons)	Energy Factor	30	0.59	50	0.55		
GAS																																								
Size (gallons)	Energy Factor																																							
30	0.64																																							
40	0.62																																							
50	0.60																																							
65	0.58																																							
75	0.56																																							
ELECTRIC																																								
Size (gallons)	Energy Factor																																							
30	0.95																																							
40	0.94																																							
50	0.92																																							
65	0.90																																							
80	0.88																																							
100	0.86																																							
OIL																																								
Size (gallons)	Energy Factor																																							
30	0.59																																							
50	0.55																																							
<p>B. Install whole-house instantaneous (tankless) water heater. (Water heater complies with DOE Standard 10CFR430)</p>	4	Installer certified																																						
<p>C. Insulate all hot water lines with a minimum of one inch insulation.</p>	4	Installer certified																																						

GUIDELINE	PTS	HOW TO VERIFY
D. Install heat trap on cold and hot water lines to and from the water heater (if not integral to the water heater).	3	Installer certified
E. Install manifold plumbing system with parallel piping configuration (aka “home run”) using smallest diameter piping allowed by code.	5	Installer certified
3.3.4 Lighting and appliances <ul style="list-style-type: none"> <li data-bbox="289 426 954 489">A. Use an ENERGY STAR Advanced Lighting Package (ALP) in home. 7 <li data-bbox="289 499 954 594">B. Install all recessed lighting fixtures within the conditioned envelope of the building, e.g., housing does not penetrate insulated ceiling. 7 <li data-bbox="289 604 954 667">C. Install motion sensors on outdoor lighting (if not credited under 3.3.4.a). 7 <li data-bbox="289 678 954 709">D. Install tubular skylights in rooms without windows. 2 <li data-bbox="289 720 954 865">E. Install ENERGY STAR-labeled appliances: <ul style="list-style-type: none"> <li data-bbox="337 751 954 783">• Refrigerator 3 <li data-bbox="337 793 954 825">• Dishwasher 3 <li data-bbox="337 835 954 865">• Washing machine. 5 		Builder certified Builder certified Builder certified Builder certified Builder certified
3.3.5 Renewable energy/solar heating and cooling <ul style="list-style-type: none"> <li data-bbox="289 919 954 1999"> 3.3.5.1 Solar space heating and cooling <ul style="list-style-type: none"> <li data-bbox="370 961 954 1999">A. Use sun-tempered design: building orientation, sizing of glazing, design of overhangs to provide shading are in accordance with guidelines below: <ul style="list-style-type: none"> <li data-bbox="410 1066 954 1129">• Long side of the home faces within 30° of south <li data-bbox="410 1140 954 1203">• Glazing area < 7% of finished floor area (FFA) on south face (Low-E) <li data-bbox="410 1213 954 1276">• Glazing area < 2% of FFA on west face (Low-E, Low SHGC) <li data-bbox="410 1287 954 1350">• Glazing area < 4% of FFA on east face (Low-E, Low SHGC) <li data-bbox="410 1360 954 1423">• Glazing area < 4% of FFA on north face (Low-E) <li data-bbox="410 1434 954 1497">• Skylights less than 2% of finished ceiling area, with shades and insulated wells <li data-bbox="410 1507 954 1999">• Overhangs designed to provide shading on south-facing glass (at a minimum), or adjustable canopies or awnings. (See User Guide for charts that indicate length of overhang, amount and period of shading according to latitude.) 	10	Builder spec sheet



GUIDELINE	PTS	HOW TO VERIFY
<p>B. Use passive solar design: sun-tempered design as above plus additional south-facing glazing, appropriately designed thermal mass to prevent overheating, and provision for airflow to adjoining rooms.</p> <ul style="list-style-type: none"> • Sun-tempered design as outlined above except additional glazing permitted on south wall <i>plus</i> • For any room with south-facing glazing > 7% of FFA, properly sized thermal mass, and • Provision for forced airflow to adjoining areas as needed • (SBIC Passive Solar Design Guidelines for your climate should be referenced to size thermal mass.) <p><i>Note: 3.3.5.1.A must also be done in order to receive points for 3.3.5.1.B.</i></p> <p>C. Use passive cooling.</p> <ul style="list-style-type: none"> • Exterior shading on east and west windows, e.g., shade trees, moveable awnings or louvers, covered porches • Overhangs designed to provide shading on south-facing glazing. Use supplied charts that indicate length of overhang, amount and period of shading according to latitude. (Not to be double-counted if credited in 3.3.5.1.A above.) • Windows located to facilitate cross ventilation • Solar-reflective roof or radiant barrier in hot climates. <p><i>Note: All of the above must be done in order to receive points for this line item.</i></p>	<p>10</p> <p>8</p>	<p>Builder spec sheet identifying passive solar design features</p> <p>Documentation of design process</p> <p>Builder spec sheet</p> <p>Documentation of design process</p> <p>Builder certified</p>
<p>3.3.5.2 Solar water heating</p> <p>A. Install solar water heating system. Must use SRCC-rated system. Solar fraction:</p> <ol style="list-style-type: none"> 1. 0.3 2. ≥ 0.5 	<p>8</p> <p>10</p>	<p>Installer certified</p> <p>Manufacturers' specifications</p>
<p>3.3.5.3 Additional renewable energy options</p> <p>A. Supply electricity needs by onsite renewable energy source such as photovoltaics, wind, or hydro whereby the system is estimated to produce the following kWh per year:</p> <p>2,000 to 3,999</p> <p>4,000 to 5,999</p> <p>6,000 +</p> <p>(Equipment should carry all applicable IEEE and UL certifications. Installation shall be in accordance with local utility and electrical code requirements.)</p>	<p>8</p> <p>10</p> <p>12</p>	<p>Installer certified</p> <p>Manufacturers' specifications</p>

GUIDELINE	PTS	HOW TO VERIFY
<p>B. Provide clear and unshaded roof area (+/-30° of south or flat) for future solar collector or photovoltaics. Minimum area of 200 sf. Provide a rough-in of piping from the roof to the utility area:</p> <ul style="list-style-type: none"> • Conduit • Insulated piping <p>C. Provide homeowner with information and enrollment materials about options to purchase green power from the local electric utility.</p> <p>(Not to duplicate points for homeowner manual in IEQ section below.)</p>	<p>3</p> <p>5</p> <p>2</p>	<p>Builder certified</p> <p>Builder certified</p>
<p>3.3.6 Verification</p>		
<p>3.3.6.1 Conduct onsite third-party inspection to verify installation of energy-related features such as:</p> <ul style="list-style-type: none"> A. Duct installation and sealing B. Building envelope air sealing details C. Proper installation of insulation including no gaps, voids, or compression D. Insulation cut accurately to fit cavity E. Windows and doors flashed, caulked, and sealed properly. <p>(When at least 100 homes of the same model are to be built by the same builder, a representative sample [15%] of homes may be inspected.)</p>	<p>8</p>	<p>Inspection may be performed by Green Building Program administrator, energy program administrator, architect, engineer, or other party outside of the builder's company and acceptable to the Green Building Program administrator.</p> <p>At least two onsite inspections should be done: one after insulation is installed and the second upon completion of the project.</p>
<p>3.3.6.2 Conduct third-party testing to verify performance, e.g., blower door, duct leakage testing, flow hood testing (per test).</p> <ul style="list-style-type: none"> A. Building envelope leakage: blower door test results < 0.35 ACH_{nat} B. Central HVAC duct leakage: duct leakage test results: <ul style="list-style-type: none"> • Leakage to unconditioned space < 5% of rated blower capacity • Total leakage < 10% of rated blower capacity C. Balanced HVAC airflows: flow hood test results: <ul style="list-style-type: none"> • Measured flow at each supply and return register within 25% of design flow. • Total airflow within 10% of design flow. <p>(When multiple homes of the same model are to be built by the same builder, a representative sample of homes may be tested subject to the sampling protocol.)</p>	<p>8 per test</p>	<p>Report showing results of testing</p> <p>Examples of those who would be qualified to perform testing include but are not limited to energy program technicians, weatherization program technicians, HVAC contractors, and energy efficiency/building science consultants.</p>

GUIDELINE	PTS	HOW TO VERIFY
<p>3.3.7 Innovative options</p> <p>A. Install drain water heat-recovery system.</p> <p>B. Install desuperheater in conjunction with ground source heat pump.</p> <p>C. Install heat pump water heater. Must be rated according to the current US DOE test standard and shall have an EF > 1.7.</p> <p>D. Install occupancy sensors for lighting control. (Points per sensor)</p>	<p>2</p> <p>6</p> <p>6</p> <p>4</p>	<p>Installer certified</p> <p>Installer certified</p> <p>Installer certified</p> <p>Builder certified</p>



		PTS	HOW TO VERIFY
4.1 INDOOR/OUTDOOR WATER USE			
4.1.1	Hot water delivery to remote locations aided by installation of: A. On-demand water heater at point of use served by cold water only. (Points per unit installed) B. Control-activated recirculation system.	6	Installer certified
4.1.2	Water heater located within 30 feet of pipe run of all bathrooms and kitchen.	9	Installer certified
4.1.3	ENERGY STAR® water-conserving appliances installed, e.g., dishwasher, washing machine	7 per appl.	Installer certified
4.1.4	Water-efficient showerhead using conventional aerator or venturi technology for flow rate < 2.5 gpm	2 per fixture	Installer certified
4.1.5	Water-efficient sink faucets/aerators < 2.2 gallons/minute	2 per fixture	Installer certified
4.1.6	Ultra low flow (< 1.6 gpm/flush) toilets installed: A. Power-assist B. Dual-flush.	4 6	Installer certified
4.1.7	Low-volume, non-spray irrigation system installed, e.g., drip irrigation, bubblers, drip emitters, soaker hose, stream-rotator spray heads	7	Installer certified
4.1.8	Irrigation system zoned separately for turf and bedding areas	6	Installer certified
4.1.9	Weather-based irrigation controllers, e.g., computer-based weather record	7	Installer certified
4.1.10	Collect and use rainwater as permitted by local code. (Additional credit for distribution system that uses a renewable energy source or gravity)	9	Builder certified
4.1.11	Innovative wastewater technology as permitted by local code, e.g., constructed wetland, sand filter, and aerobic system	7	Submit plan approved by local code or health department official
4.2 INNOVATIVE OPTIONS			
4.2.1	Shut-off valve, motion sensor, or pedal-activated faucet to enable intermittent on/off operation	6	Installer certified
4.2.2	Separate and re-use greywater as permitted by local code	6	Installer certified
4.2.3	Composting or waterless toilet as permitted by local code	6	Installer certified

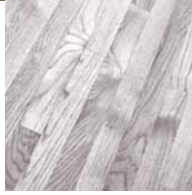

	PTS	HOW TO VERIFY
5.1 MINIMIZE POTENTIAL SOURCES OF POLLUTANTS		
5.1.1 For vented space heating and water heating equipment: A. Install direct vent equipment or B. Install induced/mechanical draft combustion equipment.	8	Builder spec sheet
5.1.2 Install space heating and water heating equipment in isolated mechanical room or closet with an outdoor source of combustion and ventilation air.	6	Builder spec sheet
5.1.3 Install direct-vent, sealed-combustion gas fireplace, sealed wood fireplace, or sealed woodstove. or Do not install fireplace or woodstove.	6	Builder spec sheet
5.1.4 Ensure a tightly-sealed door between the garage and living area, and provide continuous air barrier between garage and living areas including air sealing penetrations, walls, ceilings, and floors.	9	Builder spec sheet
5.1.5 Ensure particleboard, medium-density fiberboard (MDF) and hardwood plywood substrates are certified to low formaldehyde emission standards ANSI A208.1, ANSI A208.2, and ANSI/HPVA HP1, respectively. Composite wood/agrifiber panel products must either contain no added urea-formaldehyde resins or must be third-party certified for low formaldehyde emissions.	6	Manufacturer's spec sheet Third-party listing
5.1.6 Install carpet, carpet pad, and floor covering adhesives that hold "Green Label" from Carpet and Rug Institute's indoor air quality testing program or meet equivalent thresholds verified by a third party.	6	Manufacturer's spec sheet Third-party listing
5.1.7 Mask HVAC outlets during construction and vacuum ducts, boots, and grilles before turning on central heating/cooling system.	5	
5.1.8 Use low-VOC-emitting wallpaper.	3	Builder's spec sheet
5.2 MANAGE POTENTIAL POLLUTANTS GENERATED IN THE HOME		
5.2.1 Vent kitchen range exhaust to the outside.	7	Builder spec sheet Use guidance in homeowner's manual

		PTS	HOW TO VERIFY
5.2.2	Provide mechanical ventilation at a rate of 7.5 cfm per bedroom + 7.5 cfm and controlled automatically or continuous with manual override. The ventilation equipment may be: A. Exhaust or supply fan(s), or B. Balanced exhaust and supply fans, or C. Heat-recovery ventilator, or D. Energy-recovery ventilator.	7 9 10 10	Builder spec sheet Use guidance in homeowner's manual
5.2.3	Install MERV 9 filters on central air or ventilation systems.	3	Use guidance in homeowner's manual
5.2.4	Install humidistat to control whole-house humidification system.	4	Use guidance in homeowner's manual
5.2.5	Install sub-slab de-pressurization system or infrastructure to facilitate future installation of radon mitigation system. *The more stringent requirement between a local building code and this provision shall apply.	6	Builder spec sheet
5.2.6	Verify all exhaust flows meet design specifications.	9	
5.3 MOISTURE MANAGEMENT (VAPOR, RAINWATER, PLUMBING, HVAC)			
5.3.1	Control bathroom exhaust fan with a timer or humidistat.	6	Builder spec sheet
5.3.2	Install moisture-resistant backerboard—not paper-faced sheathing—under tiled surfaces in wet areas.	6	Builder spec sheet
5.3.3	Install vapor retarder directly under slab (6-mil) or on crawl space floor (8-mil). In crawl spaces, extend poly up wall and affix with glue and furring strips, or damp-proof wall below grade. Joints lapped 12 inches.	9	Builder spec sheet
5.3.4	Protect unused moisture-sensitive materials from water damage through just-in-time delivery, storing unused materials in a dry area, or tenting materials and storing on a raised platform.	6	Builder's moisture management practice or plan
5.3.5	Keep plumbing supply lines out of exterior walls.	5	
5.3.6	Insulate cold water pipes in unconditioned spaces with one-half-inch insulation or other coating that comparably prevents condensation.	4	Builder spec sheet
5.3.7	Insulate HVAC ducts, plenums, and trunks in unconditioned basements and crawl spaces to avoid condensation.	4	Builder spec sheet
5.3.8	Check moisture content of wood before it is enclosed on both sides. Ensure moisture content of subfloor/substrate meets the appropriate industry standard for the finish flooring material to be installed.	4	Builder's moisture management practice or plan
5.4 INNOVATIVE OPTIONS			



PTS

HOW TO VERIFY

6.1 PROVIDE MANUAL TO OWNERS/OCCUPANTS ON THE USE AND CARE OF THE HOME. MANUAL MUST INCLUDE ALL ITEMS BELOW:

- A. Narrative detailing the importance of maintenance and operation to keep a green-built home green
- B. Local green building program certificate
- C. Warranty, operation, and maintenance instructions for equipments and appliances
- D. Household recycling opportunities
- E. Information on how to enroll in a program so that the home receives energy from a renewable energy provider
- F. Explanation of the benefits of using compact fluorescent light bulbs in high-usage areas
- G. A list of habits or actions to optimize water and energy use
- H. Local public transportation options (if applicable)
- I. Clearly labeled diagram showing safety valves and controls for major house systems.

9

Copy of the home manual

6.2 OPTIONAL INFORMATION TO INCLUDE IN THE HOME MANUAL

(Choose at least five.)

- A. A list of local service providers that focus on regularly scheduled maintenance and proper operation of equipment and the structure (sealants, caulks, gutter and downspout system; shower/tub surrounds, irrigation systems, etc.)
- B. A photo record of framing with utilities installed. Photos should be taken prior to installing insulation, clearly marked, and provided in homeowner's manual.
- C. List of Green Home Building Guidelines items included in the home
- D. User-friendly maintenance checklist
- E. Instructions for proper handling and disposal of hazardous materials
- F. Information on organic pest control, fertilizers, de-icers, and cleaning products
- G. Information about native or low-water landscape

2

	PTS	HOW TO VERIFY
<p>H. Information on how to keep a home’s relative humidity in the range of 30%-60%</p> <p>I. Instructions for checking crawl space for termite tubes periodically</p> <p>J. Instructions for keeping gutters clean. Instructions should note that downspouts should divert water at least five feet away from foundation</p>		
<p>6.3 PROVIDE EDUCATION TO OWNERS/OCCUPANTS IN THE USE AND CARE OF THEIR DWELLINGS.</p> <p>A. Instruct homeowners/occupants about the building’s goals and strategies and occupant’s impacts on costs of operating the building. Provide training to owners/occupants for all control systems in the house.</p>	7	
<p>6.4 SOLID WASTE</p> <p>A. Encourage homeowners/occupants to recycle by providing built-in space in the home’s design (e.g., kitchen, garage, covered outdoor space) for recycling containers.</p>	1	

6.5 INNOVATIVE OPTIONS





		PTS	HOW TO VERIFY
7.1 PRODUCTS			
7.1.1	Product manufacturer's operations and business practices include environmental management system concepts (the product line, plant, or company must be ISO 14001 certified).	3	ISO 14001 certification
7.1.2	Choose low- or no-VOC indoor paints. VOC concentrations (grams/liter) of interior paints should be equal to or less than those specified by the EPA's Environmentally Preferable Purchasing Program: <ul style="list-style-type: none"> Interior latex coatings: Flat: 100 grams/liter Non-flat: 150 grams/liter Interior oil-based paints: 380 grams/liter 	6	Builder spec sheet Manufacturer's spec or third-party listing
7.1.3	Use low-VOC sealants. VOC concentrations for construction adhesives and sealants should meet the limits specified in the California Air Resources Board Regulation for Reducing Volatile Organic Compound Emissions from Consumer Products: <ul style="list-style-type: none"> Construction adhesives: the greater of 15% by weight or 200 grams/liter Sealants and caulks: the greater of 4% by weight or 60 grams/liter Contact adhesives: the greater of 80% by weight or 650 grams/liter 	5	Manufacturer's spec or third-party listing
7.2 INNOVATIVE OPTIONS			
7.2.1	Builder's operations and business practices include environmental management system concepts (the builder must be ISO 14001 certified).	4	ISO 14001 certification



	PTS	HOW TO VERIFY
<p>1.0 IDENTIFY GOALS WITH YOUR TEAM</p> <ul style="list-style-type: none"> • Establish a knowledgeable team and communicate in writing. • Establish a “green development” mission statement. • Identify goals and objectives. • Identify team member roles and how they relate to various phases of development. • Provide training to onsite supervisors and team members on the green development practices that will be instituted onsite. • Create a checklist to be filled out onsite that contains only those targeted green development practices that will be implemented in this project (<i>see Guideline 4a for execution of this checklist</i>). 		<p>Written list of team members</p> <p>Written project mission statement</p> <p>Written project goals</p> <p>Written project team member roles</p> <p>Training materials information</p> <p>Checklist of green development practices that will be implemented</p>
<p>2.0 SELECT THE SITE</p> <p>Select the site to minimize environmental impact.</p> <ul style="list-style-type: none"> • Avoid environmentally “sensitive areas” as identified through site footprinting process or third party. • Choose an EPA-recognized brownfield (<i>see User Guide for definition</i>). • Choose a greyfield site (<i>see User Guide for definition</i>). • Choose an infill site (<i>see User Guide for definition</i>). 		<p>Any one of the following:</p> <ul style="list-style-type: none"> • Comprehensive plan • Wetland Institute • Local jurisdiction’s guidelines • Site footprinting process results • Set of site plans <p>Confirmation from a federal, state, or local brownfield site inventory list or representative that the site is a brownfield</p>

3.0 DESIGN THE SITE

Minimize environmental impact; protect, enhance, and restore the natural features and environmental quality of the site (points for each guideline are only rewarded upon execution of these plans).

- Conserve natural resources.
- Complete a natural resources inventory that is used to drive and create the site plan.
- Create a protection and maintenance plan for priority natural resources/areas during construction. *(See Section 4 for guidance in forming the plan.)*
- Locate roads, buildings, and other built features to conserve high-priority vegetation.
- Participate in a natural resource conservation program.
- Orient streets and configure lots to allow for the majority of homes to optimize solar potential *(see the Energy Efficiency module for guidance on solar resource optimization)*
- Minimize slope disturbance.
- Limit development footprint on steep slopes (slopes greater than or equal to 25%).
- Complete a hydrological/soil stability study for steep slopes, and use this study to guide the design of all structures onsite.
- Align roads with natural topography to minimize grade to reduce cut and fill.
- Reduce long-term erosion effects through the design and implementation of terracing, retaining walls, landscaping, and restabilization techniques.
- Minimize soil disturbance and erosion.
- Phase development to minimize exposed soils.
- Use alternative means to install utilities, such as tunneling instead of trenching, use of smaller equipment, shared trenches or easements, and placement of utilities under streets instead of yards.
 - Manage storm water properly.
 - Direct storm water to a locally approved regional storm water management and treatment facility that has been designed to address water quality.
 - Preserve and utilize natural water and drainage features.
 - Develop and implement storm water management plans that minimize concentrated flows and seek to mimic natural hydrology.

PTS

HOW TO VERIFY

Pre- and post-development natural resources inventory
 Protection and maintenance plan
 Certificate or letter indicating participation in a natural resources conservation program

House plans

Hydrological/soil stability study results
 Topographical map with contour lines

Sediment and erosion control plans

Storm water management plan

PTS

HOW TO VERIFY

- Minimize impervious surfaces, and utilize permeable materials for
 - Parking areas
 - Walkways
 - Streets—minimize street widths and rights-of-way as per recommendations in either local code or in *Residential Streets, 3rd Edition*:
 - a. No on-street parking: 18 feet
 - b. Parking on one side: 22–24 feet
 - c. Parking on both sides: 24–26 feet
- Use an advanced wastewater system as an alternative to the conventional septic system and drain field, where municipal sewage is not available. Examples include sand/media filters, aerobic treatment units, and community package plants.
- Devise landscape plans to limit water demand while preserving or enhancing the natural environment.
- Formulate a plan to restore or enhance natural vegetation that is cleared during construction or development. Within this plan, phase landscaping to ensure denuded areas are quickly vegetated.
- Select turf grass and other vegetation that are native or regionally appropriate species.
- Limit turf areas of landscaped area, selecting native and regionally appropriate trees and vegetation in a way that complements the natural setting.
- Group plants with similar watering needs (hydrozoning).
- Specify planting of trees to increase site shading and moderate temperatures (*see also Energy Efficiency Guideline 3.3.5.1 specifying siting of trees to reduce the energy consumption of the home*).
- Require onsite tree trimmings of regionally appropriate species to be used as protective mulch during construction or as a base for walking trails.
- Establish an integrated pest management plan to minimize chemical use in pesticides and fertilizers.
- Maintain wildlife habitat.
- Preserve open space as wildlife corridors where possible.
- Institute wildlife habitat measures
- Participate in a wildlife conservation program.
- Prepare operation and maintenance plan (manual) for transfer of common open spaces, utilities (storm water, wastewater), and environmental management.
- Disassemble existing buildings, and reuse or recycle the building materials (deconstruction) instead of demolishing.

System specifications

Landscape plan

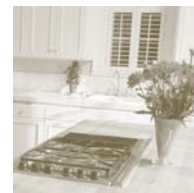

Certificate or letter indicating participation in a wildlife conservation plan

Copy of the manual

Catalogue reused or recycled building materials

	PTS	HOW TO VERIFY
<p>4.0 DEVELOP THE SITE</p> <p>Minimize environmental intrusion during onsite construction.</p> <ul style="list-style-type: none"> • Provide onsite supervision and coordination during clearing, grading, trenching, paving, and installation of utilities to ensure that targeted green development practices are implemented. • Conserve existing onsite vegetation. • Provide basic training in tree and other natural resource protection to onsite supervisor. • Minimize disturbance of and damage to trees and other vegetation designated for protection through installation of fencing and avoidance of trenching, significant changes in grade, and compaction of soil and critical root zones. • Prepare designated existing trees and vegetation for the impacts of construction through pruning, root pruning, fertilizing, and watering. • Improve the soil with organic amendments and mulch. • Minimize onsite soil disturbance and erosion. • Demarcate limits of clearing and grading. • Create construction “no disturbance” zones using fencing or flagging to protect vegetation and sensitive areas from construction vehicles, material storage, and washout. • Install and maintain sediment and erosion controls. • Stockpile and cover good soil for later use. • Reduce soil compaction from construction equipment through laying mulch, chipped wood, or plywood sheets. • Stabilize disturbed areas within the EPA-recommended 14-day period. 		<p>Protection and maintenance plan</p> <p>Protection and maintenance plan and/or set of site plans</p> <p>Sediment and erosion control plans</p>
<p>5.0 INNOVATIVE OPTIONS</p> <p>Seek to obtain waivers or variances from local development regulations to enhance green building.</p> <ul style="list-style-type: none"> • Cluster development to preserve meaningful open space. • Reduce street widths. • Share driveways or parking. • Other (specify). 		<p>Set of site plans</p> <p>Set of site plans</p> <p>Set of site plans</p>



DISCLAIMER

This publication contains guidance for builders engaged in or interested in green building products and practices for residential design, development, and construction. This publication is not intended to be exhaustive and all-inclusive, and the enclosed guidelines are not to be considered the only method of green building. These guidelines for green building originate from the collective experience of leading personnel in the green building movement (marketplace) but must, due to the nature of the responsibilities involved, be presented only as a guide for the use of a qualified developer, builder, remodeler, or design professional.

Nothing in this directory should be construed as policy, an endorsement, warranty (express or implied), or guaranty by the National Association of Home Builders (NAHB), the NAHB Research Center (Research Center), or any persons or organizations involved in the creation of this publication, of any technical descriptions, systems, details, requirements, materials, or products.

NAHB, Research Center, and the publication's authors and publishers expressly disclaim any responsibility for any damage arising from the use of, application of, or reliance on the recommendations and information contained herein.

COPYRIGHT

COPYRIGHT © 2006, by NATIONAL ASSOCIATION OF HOME BUILDERS, All Rights Reserved

No part of this publication may be reproduced, stored in a retrieval system, or transmitted in any form by any means, electronic, mechanical, photocopying, recording, or otherwise, without the prior written consent of the National Association of Home Builders. The green home building guidelines provided as Part One of this document are for the intended use of home builders and home builder associations, which agree to treat the guidelines as proprietary.

TABLE OF CONTENTS



Section 1	Lot Design, Preparation, and Construction	57
1.1	Select the Site	57
1.2	Identify Goals With Your Team	58
1.3	Design the Site	59
1.4	Develop the Site	67
1.5	Innovative Options	68
Section 2	Resource Efficiency	70
2.1	Reduce Quantity of Materials and Waste	70
2.2	Enhance Durability and Reduce Maintenance	80
2.3	Reuse Materials	86
2.4	Use Recycled-Content Materials	88
2.5	Recycle Waste Materials During Construction	90
2.6	Use Renewable Materials	91
2.7	Use Resource-Efficient Materials	93
2.8	Innovative Options	93
Section 3	Energy Efficiency	95
3.1	Implement an Integrated and Comprehensive Approach to Energy-Efficient Design of Building Site, Building Envelope, and Mechanical Space Conditioning Systems	95
3.2	Performance Measures	96
3.3	Prescriptive Path	97
3.3.1	Building Envelope	97
3.3.2	HVAC Design, Equipment, and Installation	100
3.3.3	Water Heating Design, Equipment, and Installation	108
3.3.4	Lighting and Appliances	110
3.3.5	Renewable Energy/Solar Heating and Cooling	112
3.3.6	Verification	120
3.3.7	Innovative Options	122
Section 4	Water Efficiency	127
4.1	Indoor/Outdoor Water Use	127
4.2	Innovative Options	132
Section 5	Indoor Environmental Quality	134
	General Resources	134
5.1	Minimize Potential Sources of Pollutants	134
5.2	Manage Potential Pollutants Generated in the Home	139
5.3	Moisture Management (Vapor, Rainwater, Plumbing, HVAC)	143
5.4	Innovative Options	148



Section 6	Operation, Maintenance, and Homeowner Education	149
6.1	Provide Home Manual to Owners/Occupants on the Use and Care of the Home That Includes All of the Items Below	149
6.2	Optional Items to Include in the Home Manual (Choose at Least Five)	150
6.3	Provide Education to Owners/Occupants in the Use and Care of Their Dwellings	151
6.4	Solid Waste	151
6.5	Innovative Options	152
<hr/>		
Section 7	Global Impact	153
7.1	Products	153
7.2	Innovative Options	154
<hr/>		
Appendix A	Site Planning and Land Development	156
1.0	Identify Goals With Your Team	156
2.0	Select the Site	157
3.0	Design the Site	159
4.0	Develop the Site	165
5.0	Innovative Options	167



1.1 SELECT THE SITE

1.1.1 Avoid environmentally “sensitive areas” as identified through site footprinting process or existing third-party data.

Intent:

Thoughtful site selection can be the first step in building a green home. By avoiding environmentally sensitive areas, a builder can help preserve land that might function as a corridor for wildlife, recreational open space, or habitat sanctuary. By selecting a site that has at any time been identified as an environmentally sensitive area, a builder will receive no credit for this line item, regardless of the site’s classification at the time of construction.

Information / How to Implement:

“Sensitive areas” may be identified within a comprehensive plan, by a wetland institute, or by the local jurisdiction. Other excellent sources of detailed environmental information about a site are professionals such as arborists, landscape architects, ecologists, and wildlife biologists. These experts can provide assistance in identifying a potential site’s natural resources and environmentally sensitive areas.

Resources:

- American Society of Consulting Arborists, www.asca-consultants.org/why.html
- American Society of Landscape Architects, www.asla.org/members/pigroups.cfm
- International Society of Arboriculture, www.isa-arbor.com/home.asp
- Society of American Foresters, www.safnet.org/certifiedforester/
- The Ecological Society of America, www.esa.org/

1.1.2 Choose an infill site.

Intent:

Building on an infill site can effectively conserve resources (e.g., infrastructure) and preserve open space that could be lost from “green field” development.

Information / How to Implement:

Infill areas are vacant or underutilized lots of land served by existing physical installations such as roads, power lines, sewer and water, and other infrastructure.

Resources:

- Policy Link, Equitable Development Toolkit, Infill Incentives, www.policylink.org/EDTK/Infill/.
- Northeast-Midwest Institute and Congress for the New Urbanism, *Strategies for Successful Infill Development* (2001), www.nemw.org/infillbook.htm.

1.1.3 Choose a greyfield site.

Intent:

Redevelopment of a greyfield site can provide an efficient use of land and infrastructure. Greyfield redevelopment allows for the preservation of open space and wildlife habitat in the midst of growth.

Information / How to Implement:

Within these guidelines, a greyfield is defined as “any site previously developed with at least 50% of the surface area covered with impervious material.” The development of a greyfield site can be daunting, but local or national incentives may exist to reward those builders who go through the process. Incentives may include the elimination of development-related fees, contribution from the local government in the development of offsite improvements, and tax breaks. For more information, contact the Congress for the New Urbanism, Urban Land Institute, American Planning Association, or the International Council of Shopping Centers.

Resources:

- Congress for the New Urbanism, www.cnu.org
- Urban Land Institute, www.uli.org
- American Planning Association, www.planning.org
- International Council of Shopping Centers, www.icsc.org
- Congress for the New Urbanism and PricewaterhouseCoopers, *Greyfields into Goldfields: From Falling Shopping Centers to Great Neighborhoods* (February 2001), www.cnu.org/cnu_reports/Executive_summary.pdf
- Congress for the New Urbanism and PricewaterhouseCoopers, *Greyfield Regional Mall Study* (January 2001), www.cnu.org/cnu_reports/Greyfield_Feb_01.pdf

1.1.4 Choose an EPA-recognized brownfield.**Intent:**

Remediation of a brownfield results in the environmental restoration of a polluted site, a transformation that makes an abandoned site habitable. Like greyfield and infill development, brownfield development provides an efficient use of land and infrastructure while allowing for the preservation of open space and wildlife habitat in the midst of growth.

Information / How to Implement:

The U.S. Environmental Protection Agency (EPA) characterizes brownfields as “real property, the expansion, redevelopment, or reuse of which may be complicated by the presence or potential presence of a hazardous substance, pollutant, or contaminant.” The EPA estimates that there are 450,000 such sites around the country. Grants, loans, and training are available through the EPA’s Brownfield Initiative to assist builders and developers in the remediation and development of brownfield sites.

Resources:

- U.S. Environmental Protection Agency, Brownfields Cleanup and Redevelopment: www.epa.gov/Brownfields/index.html
- The EPA has introduced two Web-based tools to give the public additional access to information about brownfield properties and cleanup efforts. The tools allow residents to locate brownfields in their area and provide access to information about cleanup grants. Go to www.epa.gov/Brownfields/bfwhere.htm

1.2 IDENTIFY GOALS WITH YOUR TEAM**1.2.1 Establish a knowledgeable team.**

- A. Identify team member roles and how they relate to various phases of green lot design, prep, and development.
- B. Create a mission statement that includes the project’s goals and objectives.

Intent:

One of the earliest challenges for a builder in developing a green lot is assembling an effective team to help the builder implement best green practices throughout the process. Those involved in the development phase must understand what the mission of the site is, what it means to be a green lot, and why green practices should be followed. Once this baseline is established, coordination and communication with and among the various team members is essential to successful development.

Information / How to Implement:

Before ground is broken, all parties that will be involved in lot development (i.e., the team) should understand that the lot will be developed as a green site. Team members may include staff, site superintendents, utilities, excavators, landscape architects, wildlife biologists, ecologists, and arborists. Once the green intent of the builder is communicated to the lot development team, the builder should work with the team throughout the development process to identify and delegate responsibilities of team members, as well as facilitate coordination between the members to achieve best green practices.

Resources:

- American Society of Consulting Arborists, www.asca-consultants.org/why.html
- American Society of Landscape Architects, www.asla.org/members/pigroups.cfm
- International Society of Arboriculture, www.isa-arbor.com/home.asp
- Society of American Foresters, www.safnet.org/certifiedforester/
- The Ecological Society of America, www.esa.org/

1.3 DESIGN THE SITE

Minimize environmental impacts; protect, restore, and enhance the natural features and environmental quality of the site.

1.3.1 Conserve natural resources.

- A. Complete a natural resources inventory used to drive/create the site plan.
- B. Create a protection and maintenance plan for priority natural resources/areas during construction. (*See Section 1.4 for guidance in forming the plan.*)
- C. Participate in a natural resources conservation program, e.g., Building with Trees.
- D. Provide basic training in tree and other natural resource protection to onsite supervisor.

Intent:

Onsite natural resources concern such features as solar energy availability, flora, fauna, water, soil, and geological formations. A natural resources inventory should be completed to identify the site's environmental attributes. A builder can then identify high-priority resources for conservation (e.g., trees, waterway, snags, and micro-habitats) and plan for the conservation of those resources during each stage of site development.

Information / How to Implement:

On complex sites, a natural resources inventory may be performed by a qualified professional such as an arborist, wildlife biologist, or landscape architect. Simpler sites, such as previously developed sites or farmland, might be adequately inventoried by knowledgeable, but less qualified, individuals. Whoever ultimately conducts the inventory should be able to discern between invasive and regionally appropriate vegetation, understand how to site a house to achieve maximum solar energy potential, be able to identify areas important to wildlife habitat, and understand how natural features can be used in managing storm water onsite.

A protection and maintenance plan should be drafted to detail how resources identified through the inventory will be protected throughout development. Section 4 of this module describes how to protect existing onsite vegetation and minimize soil disturbance and erosion through such means as installation of fencing, identification of specified washout and material storage areas, laying of mulch to reduce soil compaction, etc. In addition to protecting priority areas from intrusion during development, a maintenance plan should be created to ensure that priority vegetation survives development. Within the maintenance plan, include plans and information on fertilizing and watering trees as needed before, during, and after development.

One way to verify that the plan is implemented as planned is to create construction documents that explain how to implement the plan at each phase.

Resources:

- American Society of Consulting Arborists, www.asca-consultants.org/why.html
- American Society of Landscape Architects, www.asla.org/members/pigroups.cfm
- International Society of Arboriculture, www.isa-arbor.com/home.asp
- Society of American Foresters, www.safnet.org/certifiedforester/
- Article on preserving trees during construction:
www.umass.edu/bmatwt/publications/articles/preserving_trees_during_construction.html



1.3.2 Site the home and other built features to optimize solar resources (refer to Energy Efficiency module for guidance on solar resource optimization). (Note—do not include these points if you get points from 3.3.5.1.a or 3.3.5.1.b in the Energy Efficiency section.)

Intent:

Thoughtful orientation of a home can maximize solar heating potential in the heating season and minimize solar gains in the cooling season. Orienting a home to optimize its solar resource reduces energy use and, therefore, reduces the pollution caused by a home during its life.

Information / How to Implement:

A builder should consider such issues such as slope, storm water management, local solar angles, and high-priority vegetation when determining the optimum site for each home. The final decision in siting generally involves a compromise among these many factors.

Resources:

- See Sections 3.3.5.1.a or 3.3.5.1.b of this User Guide for resources.

1.3.3 Minimize slope disturbance.

- A. Limit development footprint on steep slopes (slopes greater than or equal to 25%).
- B. Complete a hydrological/soil stability study for steep slopes, and use this study to guide the design of all structures onsite.
- C. Align road or extended driveway with natural topography to minimize its grade and reduce cut and fill.
- D. Reduce long-term erosion effects through the design and implementation of terracing, retaining walls, and restabilization techniques.

Intent:

Leaving a slope undisturbed reduces the risk of disturbing natural hydrological drainage and causing long- and short-term erosion on the site, which can pollute water sources and damage local ecology.

Information / How to Implement:

Within these guidelines, steep slopes are defined as those slopes that are greater than or equal to 25%. Note: Points should be awarded only if there are developable steep slopes in the area.

Reduce cut-and-fill practices to help prevent unnecessary stripping of vegetation and loss of soils and reduce the need for additional resources to be brought in from offsite.

Resources:

- Prince George's County, Maryland, Department of Environmental Resources, Low-Impact Development Design Strategies: An Integrated Design Approach (EPA 841-B-00-003) (Largo, MD: June 1999), www.epa.gov/owow/nps/lid/lidnatl.pdf

1.3.4 Minimize soil disturbance and erosion. See Section 1.4 for further guidance.

- A. Schedule construction activities to minimize time that soil is exposed.
- B. Use alternative means to install utilities, such as tunneling instead of trenching, use of smaller equipment, shared trenches or easements, and placement of utilities under streets instead of yards.
- C. Demarcate limits of clearing and grading.

Intent:

Sediment and the pollutants contained in it are recognized sources of water quality problems. Exposed soils should be minimized to reduce erosion, promote water quality, and reduce damage caused to native vegetation. Heavy equipment and excessive digging can result in compaction or loss of topsoil along with the introduction of invasive and problematic flora. Minimizing soil disturbance and erosion both reduces stressors on downstream water bodies and saves valuable topsoil for the site.

Information / How to Implement:

NAHB's *Storm Water Permitting: A Guide for Builders and Developers* contains information about the federal Phase I and II storm water permitting program and the equivalent requirements for state storm water permits (see Resources section). *Storm Water Permitting* also contains technical information, including recommendations for use and cost estimates, on over 50 of the most commonly used Best Management Practices; sample Storm Water Pollution Prevention Plans; and tips on compliance, including how to handle visits from inspectors.

Methods for preventing erosion include silt fences, sediment traps, vegetated buffer areas, and mulching. More permanent solutions include biomechanical devices such as swales and vegetated buffers. Another highly effective, environmentally responsible method for preventing erosion is to use compost filter berms, compost erosion socks, and/or surface application of compost erosion control. The compost should be from organic sources like bioshields, yard waste, and wood chips. Turf and plant material—which help to facilitate the re-establishment of a natural environment—are established more quickly when organic compost is used.

Resources:

- National Association of Home Builders (NAHB), *Storm Water Permitting: A Guide for Builders and Developers*, 2005, store.builderbooks.com or 800-368-5242 x8163
- King County Department of Natural Resources, King County, Washington Surface Water Design Manual Appendix D: Erosion and Sediment Control Standards (Seattle: September 1998), [ftp://ftp.metrokc.gov/ddes/acrobat/esa/kcswdm-d.pdf](http://ftp.metrokc.gov/ddes/acrobat/esa/kcswdm-d.pdf)
- Dr. James R. Fazio, National Arbor Day Foundation, *Trenching and Tunneling: A Pocket Guide for Qualified Utility Workers* (Nebraska City, Nebraska: 1998), www.arborday.org/shopping/merchandise/merchdetail.cfm?id=62

1.3.5 Manage storm water using low-impact development when possible.

- 
- A. Preserve and utilize natural water and drainage features.
 - B. Develop and implement storm water management plans that minimize concentrated flows and seek to mimic natural hydrology.
 - C. Minimize impervious surfaces and use permeable materials for driveways, parking areas, walkways, and patios.

Intent:

Percolation through soil is one of the most effective means for filtering pollutants carried by storm water. By using natural water and drainage features, minimizing impervious surfaces, and distributing storm water flows, builders can reduce harmful pollutants carried off-site while safely and effectively managing much of their storm water load onsite.

Information / How to Implement:

Use open space and natural systems such as vegetative swales, french drains, wetlands, dry wells, and rain gardens that promote water quality and infiltration.

Resources:

- The Practice of Low Impact Development, U.S. Department of Housing and Urban Development (HUD); www.huduser.org/publications/destech/lowimpactdevl.html
- Tom Schueler, Center for Watershed Protection, Site Planning for Urban Stream Protection, Ellicott City, MD, 1995, www.cwp.org/SPSP/TOC.htm
- Lisa Austin, Washington State Department of Ecology Water Quality Program, Stormwater Management Manual for Western Washington (Publication 99-12), September 2001, www.ecy.wa.gov/pubs/9912.pdf
- Betty Rushton, Southwest Florida Water Management District, *Low Impact Parking Lot Design Reduces Runoff and Pollutant Loads: Annual Report # 1*, Brooksville, Florida, 1999

1.3.6 Devise landscape plans to limit water and energy demand while preserving or enhancing the natural environment.

- A. Formulate a plan to restore or enhance natural vegetation that is cleared during development. Within this plan, phase landscaping to ensure denuded areas are quickly vegetated.
- B. Select turf grass and other vegetation that are native or regionally appropriate species.
- C. Limit turf areas of landscaped area, selecting native and regionally appropriate trees and vegetation in a way that complements the natural setting.
- D. Group plants with similar watering needs (hydrozoning).
- E. Specify planting of trees to increase site shading and moderate temperatures (see also Energy Efficiency Guideline 3.4.1.c specifying siting of trees to reduce the energy consumption of the home).
- F. Design vegetative windbreaks or channels as appropriate to local conditions.
- G. Require onsite tree trimmings or waste of regionally appropriate trees to be used as protective mulch during construction or as a base for walking trails.
- H. Establish an integrated pest management plan to minimize chemical use in pesticides and fertilizers.

Intent:

Landscaping water use accounts for approximately 50% of a home's total water needs. Conservation of this valuable resource through such techniques as hydrozoning, reducing turf area, and selecting regionally appropriate plants is a key component to responsible building. Thoughtful selection and placement of plants can also reduce heating/cooling loads of a home, provide habitat for native fauna, and minimize the heat-island effect of developments.

Information / How to Implement:

Select landscaping materials and vegetation to fit site conditions. Regionally appropriate plants are hardy plants that can withstand local water and temperature conditions such as freeze, heat, drought, and rain. Regionally appropriate plants will also not be overly prolific or invasive, and will be able to coexist with other native plants over time.

Other benefits of landscaping with native plants: minimizes maintenance (reduces emissions of equipment), fosters wildlife habitat. See EPA's Mid-Atlantic Region Green Landscaping www.epa.gov/reg3esd1/garden/what.htm for more information.

When planning for the revegetation of a site, consider the multiple services that natural areas can provide: natural habitat, storm water processing, shading, windbreak, etc. Trees that shade the streets can keep a neighborhood cool while also increasing the neighborhood's attractiveness. Properly selected plants can be grouped to serve as a bioretention zone. Deciduous trees allow the sun's rays through in winter and provide shade in the summer. Evergreens can provide an effective windbreak. Careful selection and integration of trees and vegetation can reduce a developer's initial costs while providing value to a development or neighborhood later. When planting trees, several factors should be taken into account such as the value of shading (trees shading asphalt will mitigate a site's temperature more than trees shading landscaped areas), maintaining a safe distance from the house (especially in areas prone to natural disasters), ultimate tree size, etc.

Developers may wish to consider enforcing guidelines for the protection of onsite vegetation. Some developers even fine builders for damage to areas designated for protection.

If grinding and scattering cleared plants, care should be taken to grind only regionally appropriate plants. Grinding of invasive species can increase their propagation and result in the ultimate destruction of native species.

One of the best ways to reduce energy consumption is through passive solar design of a home—using orientation, overhangs, fenestration, etc. Landscaping to reduce energy consumption is only part of the whole effort.

It is good practice to limit ratio of turf area to total landscaped area due to maintenance requirements of turf versus native plants and regionally appropriate trees and vegetation. In some areas, there may be restrictions on the percentage of turf that the front yard must contain. Research has shown that homeowners are comfortable with having as little as 50% of the front yard composed of turf. Fewer regulations are imposed on turf-to-landscaping ratio in the backyard, so good gains might be made more easily there. For research on turf and landscape of front yard with native species, see *Nassauer, Joan. 1995. Messy Ecosystems, Orderly Frames. Landscape Journal, 14 (2), 161-170.*

In areas with low annual rainfall, one way to account for water usage is through the development and implementation of a water budget. Below is Built Green Colorado's water budgeting information.

Water Budgeting

Description

Calculate the water needs of irrigated landscapes based on plant types, land area, and irrigation system efficiency. Use the calculated water budget to apply water according to the needs of the plants and manage irrigation. Overall property water budgets can be developed to include both indoor and outdoor water requirements.

Basic Practice Guidelines

- A. The landscape design process should incorporate a general outdoor annual water budget as a guideline for irrigation design and long-term landscape management. The water budget should be developed by the landscape architect or designer as part of the plant selection and grouping process (turf, trees, shrubs, ground covers, etc.).
- B. The irrigation maintenance process should be based on calculation of a monthly and annual water budget for exist-

ing sites.

- C. Calculate the site landscape water budget by summing the water requirements calculated for each hydrozone of the landscape using either of these general formulas:

Approach #1, when Reference ET is known:

$$\text{Water Budget} = \frac{(\text{ET}_0)(\text{Kc})(\text{LA})(0.623)}{\text{IE}}$$

Where:

Water Budget = Water Needed for Plants (gallons per year)

ET₀ = Reference evapotranspiration (inches per year) for bluegrass in your area

Kc = Crop coefficient for plant type (See Appendix E for more information.)

LA = Landscaped Area (square feet)

0.623 = Conversion Factor (to gallons per square foot)

IE = Irrigation Efficiency (varies based on irrigation system)

Approach #2, when Reference ET is not known:

$$\text{Water Budget} = \text{Land Area (sq. ft.)} \times \text{Estimated Plant Water Use (gallons/sq. ft.)}$$

Where:

Estimated Plant Water Use = Estimated water use in gallons/sq. ft. for the metro-Denver Front Range area. For other areas, water use estimates may need to be increased or decreased based on climate and location characteristics. Water use estimates may also be reduced when more efficient irrigation systems such as drip irrigation are used.

- D. The water budget provides the annual irrigation that the site needs in order to thrive in addition to natural precipitation. The annual water budget assumes a normal year of natural precipitation (14 inches of annual precipitation for the Front Range area). In either wetter or drier years, the water budget will need to be adjusted.
- E. The rate at which plants lose water to the surrounding air is called evapotranspiration (ET). Temperature, humidity, wind, and light all influence the ET rate. When watering, it is only necessary to replace the amount of water that has been lost due to ET.
- F. In order for water budgets to be accurate, it is necessary to provide accurate information on factors such as crop coefficients. See the GreenCO Web site www.greenco.org and Appendix E for recommended crop coefficients to be used in calculating water budgets.
- G. It should be noted that the ET₀ (reference ET) in the water budget equation does not reflect that Kentucky bluegrass can be attractive and viable at much lower ET rates and can be very drought tolerant. For properly established turf, the actual irrigation water needs of turf can vary, depending on desired appearance.
- H. The water budget does not apply to the initial establishment period for plantings, which can vary from two to four weeks for annuals to several growing seasons, depending on plant type and the timing of planting. One year is typical for many perennials and shrubs to become established.
- I. Water features, outdoor pool(s), and/or any other outdoor water uses should be included in the water budget.
- J. If a property manager/landscaper knows the water budget for each month, he/she can compare actual use to the site water budget and adjust irrigation practices accordingly. Excessive water use may also be attributed to irrigation system deficiencies, which should be corrected.

- K. Evapotranspiration (ET) or “smart” irrigation controllers can facilitate landscape irrigation according to the needs of the plants (and therefore the water budget).
1. Low-water-use plants don’t automatically save water (they are easily, and frequently, over-watered). Using a “smart” controller can ensure the proper irrigation is applied to low-water-use plants.
 2. High-water-use plants (such as turf) don’t automatically waste water. They are also often over-watered. Using a “smart” controller can ensure the proper irrigation is applied to high-water-use plants.
- L. Often the retrofitting of poor irrigation systems and the use of “smart” controllers will provide a payback in saved water. To calculate the payback time, use the water budget to measure how much water is actually needed, versus how much has historically been used, along with local water rates and irrigation system cost.
- M. GreenCO provides a simple water budget calculator on its Web site www.greenco.org. Green industry professionals can use this calculator with customers to demonstrate that water budgeting is a manageable approach to understanding water needs for a given property and adjusting watering practices accordingly.

Regional or Industry Considerations/Adaptations

- A. Water budgets can be used by water utilities to determine how much water is needed versus how much the utility sells or has.
- B. Water budgets can be used by water utilities to determine how much water they need versus how much they sell or have. The difference is how much water could be saved, or how much more water needs to be purchased.
- C. Water budgeting approaches adopted by utilities typically include ET-based irrigation scheduling combined with tiered pricing for increasing water usage. Tiered pricing, by gradually increasing the price of water as consumption rises, provides incentive to conserve. At the time of this manual’s publication, this approach had been adopted in other water-limited states such as California and Arizona. See Centennial Water and Sanitation District in Highlands Ranch, Colorado, for information on their program <http://www.highlandsranch.org/6/6-1a.html>.
- D. Colorado’s Water Efficient Landscape Design Model Ordinance (see www.dola.state.co.us/smartgrowth/) is based on water budgeting with a goal of 15 gallons/square foot/year of water required for a landscaped area.
- E. Check the GreenCO Web site (www.greenco.org) for more information on water budgeting techniques.

Key References

- Ash, T. 1998. *Landscape Management for Water Savings: How to Profit from a Water-Efficient Future*. Orange County, CA: Municipal Water District of Orange County.
- California Department of Water Resources. 1993. Model Water Efficient Landscape Ordinance. www.owue.water.ca.gov/landscape/ord/ord.cfm.
- Centennial Water and Sanitation District. 2004. Water Conservation Program. www.highlandsranch.org/06_wsan/06_3watercons.html. Highlands Ranch, CO: Centennial Water and Sanitation District.
- Colorado Department of Local Affairs. 2004. Water Efficient Landscape Design Model Ordinance. www.dola.state.co.us/smartgrowth/. Denver, CO: Colorado Department of Local Affairs, Office of Smart Growth.
- Colorado State University Cooperative Extension Drought Task Force. 2004. www.drought.colostate.edu/.
- Design Studios West, Inc.; J.M. Knopf; HydroSystems KDI, Inc.; The Restoration Group, Inc.; and G. A. White. 2004. *WaterWise Landscaping Best Practice Manual: A Companion Guide to Water Efficient Landscape Design*. www.dola.state.co.us/smartgrowth/. Denver, CO: Colorado Department of Local Affairs, Office of Smart Growth.
- GreenCO. 2004. Water Budget Calculator at www.greenco.org.

McStain Neighborhoods. 2003. *Water Conservation Standards for Common Areas and Open Space Landscapes*. Boulder, CO: McStain Neighborhoods.

Mecham, B. 2004. Scheduling Methods Using ET as a Management Tool. www.nwcd.org/ims/ims_info/scheduli.pdf. Loveland, CO: Northern Colorado Water Conservancy District.

Northern Colorado Water Conservancy District. 2004. Turfgrass Irrigation Management Program. www.nwcd.org/ims/scheduler.asp. Loveland, CO: Northern Colorado Water Conservancy District.

Slack, E. 2001. Case History: Irrigation on a Water Budget, *Irrigation Business and Technology*, March/April. (www.irrigation.org).

Resources:

- Center for Plant Conservation, www.mobot.org/CPC/
- Lady Bird Johnson Wildflower Center, Native Plant Information Network National Suppliers Directory, www.wildflower2.org/NPIN/Suppliers/suppliers.html
- New England Wildflower Society, Native Plant Societies of the United States and Canada, www.newfs.org/nps.htm
- NAHB Research Center Inc., *Onsite Grinding of Residential Construction Debris: The Indiana Grinder Pilot*, February 1999

1.3.7 Maintain wildlife habitat.

Intent:

As the frontier of home building continues to expand, sharing the land with wildlife becomes an increasing challenge to builders. Through individual initiative or participation in a wildlife conservation program, home builders can work to create a habitat where both wildlife and humans can thrive—whether in an urban, suburban, or rural setting.

Information / How to Implement:

(Extra points) Participate in a wildlife conservation program.

Examples of programs: USDA National Resources Conservation Service’s Backyard Conservation Plan, the Audubon Cooperative Sanctuary System’s Treasuring Home Initiative, or the National Wildlife Federation’s Backyard Wildlife Habitat Program.

Enhance quality of habitat, including food sources, diversity of habitat, and protective areas, through selective plantings and site design.

Leave snags (dead tree or portion that’s left for habitat). Provide birdhouses.

Resources:

- Audubon International, Audubon Cooperative Sanctuary System, www.audubonintl.org/programs/acss/. Audubon Cooperative Sanctuary System’s Treasuring Home Initiative.
- Become a certified participant in the National Wildlife Federation’s Backyard Wildlife Habitat Program.

1.4 DEVELOP THE SITE

Minimize environmental intrusion during onsite construction.

1.4.1 Provide onsite supervision and coordination during clearing, grading, trenching, paving, and installation of utilities to ensure that targeted green development practices are implemented (see 1.3.4).

Intent:

The noblest intentions when designing a site are practically achieved through onsite supervision during the lot development phase. A qualified member(s) of the builder's team should be onsite as these activities progress to ensure that each objective is achieved according to targeted green lot specifications.

Information / How to Implement:

See documents line item 1.3.4.

Resources:

Information will be added in Version 2.

1.4.2 Conserve existing onsite vegetation.

- A. Minimize disturbance of and damage to trees and other vegetation designated for protection through installation of fencing and avoidance of trenching, significant changes in grade, and compaction of soil and critical root zones.
- B. Prepare designated existing trees and vegetation for the impact of construction by pruning, root pruning, fertilizing, and watering.

Intent:

After a builder has identified (during the planning stage) the existing vegetation that will be conserved onsite, practical steps must be taken during the development stage to achieve the intended conservation. Such steps include pre-development preparation of the vegetation and protection of the foliage, soil, and root system of designated vegetation.

Resources:

- National Arbor Foundation, Building With Trees, www.arborday.org/programs/Buildingwithtrees/index.cfm
- Phillip A. Pratt and Michael W. Schnelle, Oklahoma State University, Oklahoma Cooperative Extension Service, Site Disturbance and Tree Decline (OSU Extension Facts F-6429), September 2003, <http://osuextra.com/pdfs/F-6429web.pdf>

1.4.3 Minimize onsite soil disturbance and erosion.

- A. Demarcate limits of clearing and grading.
- B. Create construction "no disturbance" zones using fencing or flagging to protect vegetation and sensitive areas from construction vehicles, material storage, and washout.
- C. Install and maintain sediment and erosion controls.
- D. Stockpile and cover good soil for later use.
- E. Reduce soil compaction from construction equipment by laying mulch, chipped wood, or plywood sheets.
- F. Stabilize disturbed areas within the 14-day period recommended by the EPA.

G. Improve the soil with organic amendments and mulch.

Intent:

This guideline seeks to ensure the field implementation of conservation plans. Each measure identifies a practical way to foster water quality and conserve onsite ecological habitat by reducing soil disturbance and erosion.

Information / How to Implement:

Soil stabilization may be temporary or permanent.

Keep in mind that, while the use of stockpiled onsite soil is a preferred method, excavation, stockpiling, grinding, and screening destroy the ecological microsystem of the soil. Rejuvenation of the unimproved soil to its original form will take several years. To offset this phenomenon, the incorporation of compost and sand is an effective method for more rapidly rebuilding the structure and ecosystem of the topsoil and allowing turf and plants to establish more quickly. As indicated above, compost is recommended for this purpose.

When additional soil must be brought in, there are environmental advantages of using industrial by-products as ingredients in topsoil including foundry sand, biosolids compost, and other EPA-approved by-products. In addition to keeping these materials out of community landfills, processing techniques produce superior topsoil.

The use of organic mulch is an excellent way to conserve water in landscape beds and to build soil quality. Ideally, use mulch that results from onsite recycling efforts such as yard waste, processed pallets, and other clean wood from construction waste.

Resources:

- King County Department of Natural Resources, King County, *Washington Surface Water Design Manual Appendix D: Erosion and Sediment Control Standards* (Seattle: September 1998), <ftp://ftp.metrokc.gov/ddes/acrobat/esa/kcswdm-d.pdf>

1.5 INNOVATIVE OPTIONS

Seek to obtain waivers or variances from local development regulations to enhance green building.

1.5.1 Share driveways or parking.

Intent:

Sharing driveways or parking can reduce the amount of impervious material on a lot, thereby decreasing storm water and pollution runoff.

Information / How to Implement:

Information will be added in Version 2.

Resources:

Information will be added in Version 2.

1.5.2 Other (specify).

Information will be added in Version 2.

(A note regarding defining “low maintenance” materials: For certain types of building products, the buyer should be on the lookout for materials that have below-average maintenance needs compared with other products in that same material category (e.g., composite decking or treated lumber). Although existing green builder programs provide good information for builders to emphasize the long-term advantages and savings of more durable, lower-maintenance products, there is no standardized method to assess the durability of residential construction materials or systems or to define “low maintenance.” A possible approach that green home building program administrators can use at this time is to give credit for extended warranties on materials and workmanship. The person choosing the building product should consider using manufacturer claims, warranty duration, third-party certifications, and sources such as GreenSpec Directory, and Life-Cycle Assessment (LCA) tools that are under development as proxies to identify “low maintenance” or “durable” materials during the purchasing process.)

2.1 REDUCE QUANTITY OF MATERIALS AND WASTE

2.1.1. Create an efficient floor plan that maintains a home's functionality

Intent:

Use the local data regarding the average size of homes built (taking bedrooms into account), and get credit for building a home with the same number of bedrooms but with fewer square feet than an average-sized house.

Size homes, rooms, and wall heights based on available material sizes. Two-foot modules work well for floor plans. Wall height should be based on availability of structural framing members in pre-cut lengths (i.e., precut stud lengths).

Use designs that incorporate efficient mechanical systems layout, like stacked “wet walls” for efficient plumbing layout, minimized pipe runs, and rapid hot water delivery. Dedicate one “wet wall” per floor, i.e., kitchen sink and powder room or master and guest baths with back-to-back layouts that share a plumbing wall. Locate walls that contain drain/waste/vent and supply pipes on interior walls. (Section 5.3.5, Indoor Environmental Quality, also covers the design practice of installing water supply lines on interior walls.)

When homes require forced-air space conditioning, incorporate the HVAC duct layout in the architectural plan and design the ducts into the conditioned space of the building to maximize system efficiency.

Information / How to Implement:

NAHB Research Center national survey data regarding average size of homes:

- 2 BR = 1,382 sq. ft.
- 3 BR = 1,890 sq. ft.
- 4 BR = 2,648 sq. ft.
- 5+ BR = 3,424 sq. ft.

In the table below, note that the square footage of a 2 BR house must be reduced by 50 square feet to obtain an additional point. In order to determine how much the homes with 3, 4, and 5+ bedrooms must be reduced, we referenced the national data (see above). The average 3 BR house is 37% larger than the average 2 BR; the average 4 BR is 40% larger than the average 3 BR; the average 5+ BR home is 29% larger than the average 4 BR. These percentages were used in the table below to determine the house size thresholds.

For example,

- a 1,825 sf. home is 37% larger than a 1,332 sf. home;
- a 2,555 sf. home is 40% larger than a 1,825 sf. home;
- a 3,296 sf. home is 29% larger than a 2,555 sf. home.

GUIDELINES FOR EFFICIENT FLOOR PLAN DESIGN

Area of Home (Square Feet) (Based on ANSI Z765-2003)	# of Bedrooms				Points
	2	3	4	5+	
1382	1890	2648	3424	0	
1332	1825	2555	3296	1	
1282	1756	2459	3172	2	
1232	1688	2363	3048	3	
1182	1619	2267	2925	4	
1132	1551	2171	2801	5	
1082	1482	2075	2677	6	
1032	1414	1979	2553	7	
982	1345	1883	2430	8	
932	1277	1788	2306	9	

Resources:

- Use the newly modified American National Standards Institute (ANSI) Z765-2003 to calculate square footage. Available from the NAHB Research Center Bookstore—
www.nahbrc.org/tertiaryR.asp?TrackID=&CategoryID=1652&DocumentID=2636
- Oikos®, Small, Efficient and Beautiful, 17 Space Design Tips. <http://oikos.com/esb/52/smallefficient.html>
- There are many resources available to help a builder create efficient home floor plans. For example, Sarah Susanka's *Not So Big House* series of books can assist in home design. *The Not So Big House* (The Taunton Press, 1998); *Creating the Not So Big House* (The Taunton Press, 2000)
- GreenBuilder, Sustainable Building Sourcebook, www.greenbuilder.com/sourcebook/
- Environmental Building News and BuildingGreen.com, GreenSpec Directory
www.greensage.com/BOOKS/GreenSpecs.html

2.1.2. Use advanced framing techniques that reduce the amount of material used to build a home while maintaining the structural integrity of the home.

Intent:

Advanced Framing or Optimum Value Engineering refer to framing techniques that reduce the amount of materials used to build a home while maintaining its structural integrity. An optimum value-engineered assembly tends to use less energy for space conditioning because the omitted (and redundant) structural components can be displaced with insulation. Accordingly, the user will note that some advanced framing techniques receive points for both Resource Efficiency and Energy Efficiency.

Information / How to Implement:

Advanced framing elements can be applied independently, or adopted in their entirety, depending upon the specific requirement(s) of the project. Framers unfamiliar with the techniques may need training, and the initial use of these techniques may temporarily slow down framing operations. In general, more planning is needed to implement these elements.

In addition to the advanced framing techniques described below for wood, homes with steel framing can incorporate advanced framing techniques, including 24-inch on-center spacing for steel floors and walls, described in the HUDUSER's Prescriptive Method for Residential Cold-Formed Steel Framing (*see Resources section of this line item for additional information*).

Some of the benefits of advanced framing include:

- Reduced first cost (3% to 5% of framing cost)
- Improved energy efficiency (2% to 5% per year)
- Improved resource efficiency (less wood consumption and waste).

Advanced framing uses engineering principles to minimize material usage while meeting model building code structural performance requirements.

The following list covers different principles that form an advanced framing system:

- 19.2-inch or 24-inch on-center framing, floor systems
- 19.2-inch or 24-inch on-center framing, bearing walls
- 24-inch on-center framing, roof systems
- 24-inch on-center interior partitions
- Single top plate walls
- Right-sized headers or insulated (box) headers (where required)
- Eliminate headers in non-bearing walls
- Doubling the rim joist in lieu of header (2x6 or deeper wall framing)
- Ladders blocking at interior-wall-to-exterior-wall intersections
- Two-stud corner framing

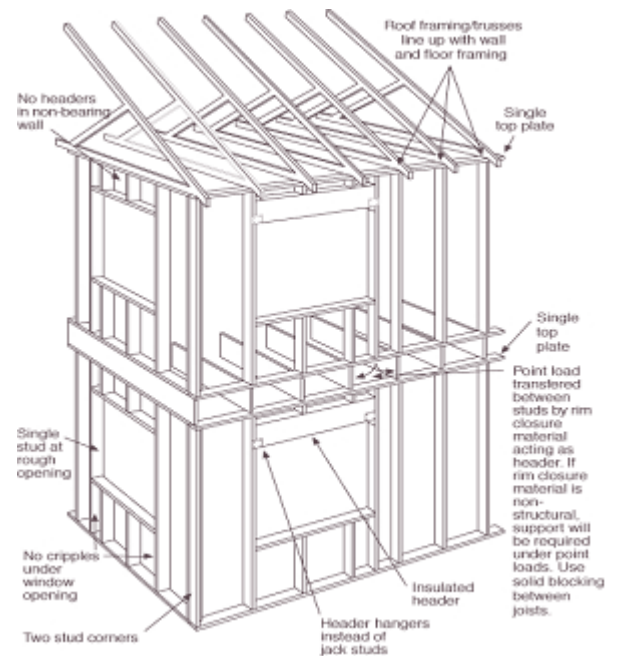

Builders need to employ at least two of the items above in order to get four points for this line item. An additional point may be added for each additional technique employed to a maximum of eight points.

19.2-inch and 24-inch ON-CENTER FRAMING

Details: Wall and floor framing spacing can often be engineered for 19.2-inch (one-fifth of an eight-foot sheet) or 24-inch on center (one-fourth of an 8-foot sheet). Roof framing that utilizes trusses is most frequently spaced at 24-inches. This strategy can be combined with modular layout and single top plate for added economy but can also be used independently.

Installation: Installation should be in accordance with manufacturer's specifications and model building code prescriptive methods. Bracing and fastening schedules and sheathing thickness requirements increase with framing spacing.

Careful spacing of window and door openings will maximize the economy of wider spacing. Designs that are built repeatedly should include wall framing layout drawings to guide the framing crew. When first implementing advanced framing elements, crews are likely to be slowed down until they become more familiar with the method.

Benefits/Cost: Approximately one-third of the lumber can be eliminated from the wall and floor framing of a value-engineered house, over walls and floors spaced 16 inches on center. Floor joists may need to be deeper for wider spans, but the reduction in lumber required for the building usually offsets the price increase from having larger floor joists. The need for thicker deck sheathing will also offset a portion of the savings. A careful analysis or a trial prototype is needed to determine whether the wider spans make economic sense for a particular plan. In general, simpler plans designed on a two-foot module are much more likely to result in savings with 24-inches on center framing than are complex plans with odd dimensions and many small offsets. However, resource savings will occur regardless of economic savings.

Wider stud spacing contributes to energy efficiency by reducing the amount of lumber in a wall cavity. Since more insulation and less lumber is used, and since insulation has a higher R-value than lumber, increasing stud spacing increases the overall R-value of the wall system. Limitations: Floor decking, wall cladding, roof sheathing, and interior finish material (such as gypsum wallboard) need to be sized to span the added dimension without undesirable deflection. If floor joists are chosen that have wide flanges, this will reduce the clear span of the floor decking. Material fastening schedules and sheathing thicknesses become more stringent when wider spans are employed, which may affect quantities, installation time, and cost of accessories.

One-half-inch-thick gypsum board will deflect somewhat more over 24-inch framing than 16-inch framing, although it is commonly used. An alternative would be to use half-inch “anti-sag” or five-eighths-inch” gypsum board.

Some manufacturers do not make insulation batts for 19.2 inches on center framing. Therefore, using this spacing in an insulated wall assembly may require changing type or brand of insulation.

In some markets, there is a perception that wide-spaced framing is a mark of inferior construction. Attention to all of the details of assembly, including fastening and bracing schedules, will assure that the system performs well.

Code/Regulatory: Model codes allow bearing walls framed with 2x4 studs spaced 24 inches on center or single top plates on bearing walls within defined structural guidelines. Designs in high-wind zones or with tall walls may not allow 24-inch on-center spacing.

SINGLE TOP PLATE—EXTERIOR AND BEARING WALLS

Details: Single top plates are typically incorporated with advanced framing designs that include 24 inch on center framing. By stacking the wall and roof framing, it is possible to use a single top plate because the top plate merely transfers compressive vertical loads to the stud below. Steel plates or straps are used to maintain continuity of the plate in the absence of a second, overlapping plate.

Installation: Temporary bracing is needed to steady and plumb newly erected walls. As with all light frame structures, temporary bracing should be left in place until the floor and/or roof is completed to permanently brace the structure.

Benefits/Costs: In a 28-foot x 40-foot two-story house, the savings from eliminating second top plates in bearing and non-bearing walls is equivalent to eliminating about 35 studs. Because one plate is omitted, the amount of wall insulation is increased, slightly improving energy performance.

Limitations: May not work on homes in high-wind or earthquake zones. Requires purchasing a longer stud.

Code/Regulatory: Meets model codes in some designs, but is more likely than other OVE practices to raise questions from building officials.

SINGLE TOP PLATE—INTERIOR NON-BEARING PARTITIONS

Details: Any non-bearing partition can be built with a single top plate.

Installation: Bracing is needed to steady and plumb recently erected walls. This bracing should be left in place until the floor or roof above the walls is completed, tying the structure together.

Benefits/Costs: Savings depend on the design’s linear feet of non-bearing walls. In a 2,200-sq. ft. home, the equivalent of two or three dozen studs is likely to be saved on interior walls.

Limitations: If used along with a normal double plate on bearing and exterior walls, two lengths of wall studs are required on the job, which could be confusing.

Code/Regulatory: Meets codes but is more likely than other OVE techniques to inspire questions from the building official.

RIGHT-SIZED HEADERS or INSULATED BOX HEADERS

Details: Instead of sizing all headers in bearing walls to accommodate the greatest load case, size each header for its actual load and span using the appropriate wood species. Also consider the benefit of using a deeper, single-ply, and engineered wood header.

If the tedium of framing different header depths to uniform head heights at openings is daunting, use insulated box headers that facilitate load transfer above openings and use fewer resources than two-ply solid sawn members. Typically, a boxed header design consists of a top and bottom 2x4 on the flat, some end and interior cripples, and a plywood face on one or two sides. The hollows in the header interior allow insulation to be added.

Installation: Headers of various sizes require framers to pay attention to plans and customize openings. An alternative would be to site-fabricate and insulate box headers of a consistent depth and install these in lieu of dimensional or engineered wood headers.

Benefits/Costs: Material cost and usage economies must be balanced against the chance of installing the wrong-sized header and slowing down the framing process by making opening head framing inconsistent. Similarly, material economies associated with fabricating box headers of consistent depth will be offset by labor involved with fabricating these onsite. The need to have an additional material, insulation, on hand at the rough frame stage makes the bill of materials more complex.

Reducing the use of large-dimensioned lumber is environmentally desirable.

Limitations: Without thoughtful implementation, right-sizing headers could result in uneven window and door head heights. The practice requires cutting different-sized cripples over headers.

Code/Regulatory: Model building codes include prescriptive methods for sizing headers and girders, as well as sizing and constructing box headers.

NO HEADERS IN NON-BEARING PARTITIONS

Details: Although it is obvious that headers are not needed in non-bearing partitions, it is not always obvious which partitions are load bearing and which are not. Thus, framers often put headers over every opening to be safe. Eliminating these headers saves both material and labor.

Installation: If a method of identifying bearing walls versus non-bearing partitions is included on the plans, the layout framer can determine which openings need headers. For instance, solid blue walls can denote bearing and uncolored walls can be non-bearing.

Benefits/Costs: Saves material and labor cost, and conserves resources by reducing the use of wide-dimension lumber.

Limitations: None.

Code/Regulatory: Model codes do not prescribe headers in non-bearing locations, although it may be necessary to demonstrate to the inspector that a partition is non-bearing.

LADDERS AT PERPENDICULAR WALL INTERSECTIONS

Details: Use flat horizontal blocking between studs to secure a perpendicular wall rather than solid vertical framing. (With 24 inches on center wall framing, three 22-1/2-inch scrap pieces are set at 24 inches on center vertically to replace two studs.)

Installation: Cutting and nailing three pieces of blocking requires approximately the same labor as installing two studs.

Benefits/Costs: Less lumber is used, and scrap pieces can be used for blocking. The horizontal blocking stiffens the wall junction. Most important, insulation in the exterior wall can be installed continuously behind the ladder frame.

Limitations: Blocking should be set so that it does not conflict with light switches and outlets.

Code/Regulatory: The system has no impact on model codes.

TWO-STUD EXTERIOR CORNER FRAMING

Details: Only two studs are needed at an outside building corner, one at the end of each intersecting wall end. Any additional framing is needed only to support the gypsum board at the inside corner. Gypsum can be supported either with a flat stud, to leave an open-ended cavity at the corner; or with drywall clips, thus eliminating the need for a third stud.

Installation: If using a third stud for gypsum board backing, the extra stud can be a 2x4, even if the wall is composed of 2x6 studs.

Benefits/Costs: With a two-stud corner, one stud is eliminated. In all cases, the open cavity at the corner can be insulated along with the wall, eliminating the need for the framer to insulate a closed cavity before the sheathing goes on.

Limitations: Drywall clips are unfamiliar to some builders and subcontractors. Exterior corner trim or cladding may result in being secured to the sheathing only and not to the stud.

Code/Regulatory: More studs may be required at corners in high-wind or earthquake zone construction.

Availability: Drywall clips are readily available.

DOUBLING THE RIM JOIST IN LIEU OF HEADER (2x6 or wider wall construction)

Details: In thick wall construction, 5 1/2-inch or greater actual wall dimension, it is possible to have the floor system rim board act as the header, or one member of a two-ply girder or header assembly, at the door or window openings located below that member.

Installation: The joists that frame into this structural member will be shorter than other joists if the design requires a two-ply member to carry the span across the opening. Multiple-member headers should be properly fastened to assure load sharing.

Benefits/Costs: Some labor may be saved in framing the header, but extra labor and thought are involved in fitting perpendicular joists inside the two-ply assembly and framing the opening height down. The concept works best for long spans where the extra depth of the member or additional height of the opening is needed. The design is also an efficient method for use above openings in foundations.

Limitations: If the rim joist is intended to act along with the extra member (or by itself), it must be continuous across the opening.

Code/Regulatory: This is an unusual technique and may inspire questions from the inspector.

Resources:

- NAHB Research Center, *Advanced Framing Techniques: Optimum Value Engineering*, www.nahbrc.org/tertiaryR.asp?TrackID=&DocumentID=2021&CategoryID=70
- HUDUSER, *Prescriptive Method for Residential Cold-Formed Steel Framing*, www.huduser.org/publications/destech/pm2.html
- Building American, DOE, *Optimum Value Engineering Best Practices*, (September, 2002), www.ibacos.com/pubs/OptimumValueEngineering.pdf
- DOE, *Advanced Framing for Walls and Ceilings*, www.energy.state.or.us/code/respub/res10.pdf
- International Code Conference, *2003 International Residential Code®*, Panel Box Headers, Table R602.7.2, pg. 123, and Fig. R602.7.2, pg. 124

2.1.3 Use building dimensions and layouts that maximize the use of the resources without the need to cut materials.**Intent:**

Use of standard or modular dimensions in layout will reduce waste by not having to cut materials.

Information / How to Implement:

Modular dimensioning was adopted in the late 1960s and is widely used. Adherence to modular dimensioning can reduce waste of material on the job site.

- One side of a door and window opening located at regular 16-inch or 24-inch stud positions.
- Modular window sizes used, with both side studs located at normal 16-inch or 24-inch stud positions.
- Building dimension in the direction parallel to the primary joist span is evenly divisible by four feet.
- Building dimension in the direction perpendicular to the primary joist span is evenly divisible by two feet.

Building to a 2-foot module and using 24-inch on-center wall and floor framing will maximize framing material resource efficiency and cost savings. Few homes can be entirely confined to a rigid module because typical dimensions such as the width of a tub or corridor are not in two-foot modules. To maximize savings, window sizes and placement should be coordinated with the two-foot module.

Resources:

NAHB Research Center, PATH technology list, *Advanced Framing Techniques: Optimum Value Engineering (OVE)*, www.toolbase.org/tertiaryT.asp?TrackID=&DocumentID=2021&CategoryID=70

2.1.4 Create a detailed framing plan and detailed material takeoffs. Provide an onsite cut list for all framing and sheathing material.**Intent:**

Recognize the benefits of careful planning in the design, purchase, and installation phases. A framing plan provides a blueprint for the layout of each piece of lumber. A plan eliminates redundant (off-layout) studs at window openings or joists at stair and mechanical chase openings that can act as thermal bridges. The layout provides an accurate count for generating a bill of materials that reduces job-site waste.

Information / How to Implement:

A detailed framing plan can be as complex as a three-dimensional perspective generated in a computer-assisted-design (CAD) program or as simple as a one-eighth-inch scale drawing detailing the floor, wall, roof, lumber, or component layout, dimensions for rough opening(s), headers and girders, and blocking locations. The following pages show examples of a wall framing plan using advanced framing techniques.

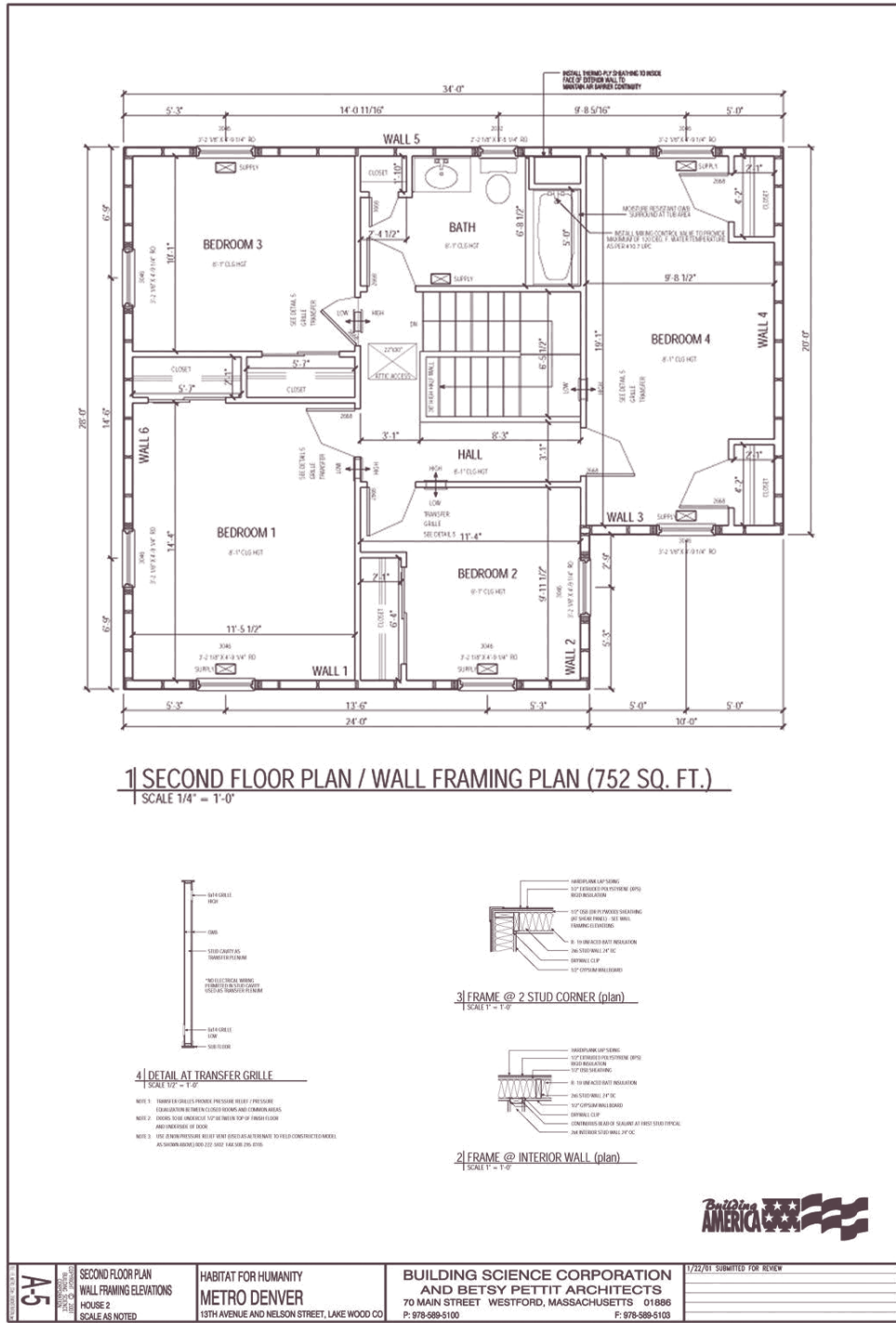



2.1.5. Use building materials that require no additional finish resources to complete application onsite.

Intent:

Materials that do not require additional finish resources save on priming, painting, and/or additional resources at the installation stage. Additionally, fewer resources are needed for recurring maintenance.

Information / How to Implement:

Ask manufacturer or installer whether a product requires any additional finish.

Examples (not an exhaustive list):

- Pigmented and stamped concrete-surfaced interior floors (of a slab-on-grade foundation).
- Exterior trim not requiring paint or stain.
- Windows with finished surfaces not requiring paint or stain.
- Siding not requiring paint or stain.

Resources:

Information will be added in Version 2.

2.1.6 Use pre-cut or pre-assembled building systems or methods.

- A. Provide a pre-cut (joist) or pre-manufactured (truss) floor and roof framing package (points provided for a flooring or roof framing package—additional points provided if both packages are done).
- B. Provide a panelized wall framing system.
- C. Provide a panelized roof system.
- D. Provide modular construction for the entire house.

Intent:

Utilizing materials that do not require additional resources and/or onsite assembly optimizes plant manufacturing efficiencies and offers protection from the elements. Less time (site impact) and resources are spent onsite.

Information / How to Implement:

For Option A, the builder would receive three points for using a flooring package, three points for a roof framing package, or six points for using both.

Pre-cut material packages—A pre-cut floor or roof package can be bundled and shipped for sequencing of use in layout and covered to minimize exposure to the elements. Pieces are marked by location on a layout plan that is provided on the blueprint or with the package. Package delivery can be scheduled for just-in-time delivery to minimize site disturbance. Not having to cut or calculate the position of the components of the floor system speeds assembly, eliminates onsite waste, and saves labor. Contractor-focused lumberyards and component manufacturers that supply engineered wood will have the resources to provide this value-added service. Another resource is building material supply dealers that supply steel stud framing packages.

Pre-manufactured component packages—Open-web floor or roof truss packages also benefit from the efficiencies listed above for pre-cut material packages. Because building components can be engineered with 2x4 and 2x6 lumber to perform as capably as wide-dimension lumber, components present an opportunity to reduce the resources in a home. Often, the reduced amount of board feet of lumber in the component facilitates easier handling because of the reduced weight.

Panelized construction—Open wall panels manufactured in a factory benefit from efficient purchasing and use of materials, automated cutting and fastening methods, and assembly in an environment that is protected from the elements. Panels are custom manufactured and delivered to meet the builder’s schedule. A layout plan aids the carpenter in assembling the walls onsite. Using panels can save several days in the critical path of assembly and speed the process of “closing in” the home.

Modular construction—Entire sections of the home are constructed and transported to the site. Modular housing goes further in reducing waste onsite, since the unit is delivered to the site 70 to 85% finished. Modules are moved onto a site-built foundation, connected, repaired at common junctions, and tied in to utilities. Homes can be made ready for move-in within one week.

Resources:

- NAHB, Building Systems Council, Fast Facts: Systems-Built Housing, www.nahb.org/generic.aspx?sectionID=455&genericContentID=10216 and www.buildingsystems.org
- U.S. HUD, Builders’ *Guide to Residential Steel Floors*, www.huduser.org/Publications/PDF/steelfloor.pdf

2.1.7 Install a frost-protected shallow foundation (FPSF).

Intent:

Minimize the excavation and site disturbance for foundations. Frost-protected shallow foundations use fewer materials than conventional foundations.

Information / How to Implement:

An FPSF incorporates strategically placed insulation to raise soil temperature and the frost depth around a building, thereby allowing foundation depths as shallow as 16 inches for almost all areas of the continental United States. Model codes have recognized frost-protected shallow foundation design principles since 1995. Performance has been proven in cold climates like Scandinavia, where FPSFs have been installed for the past 75 years.

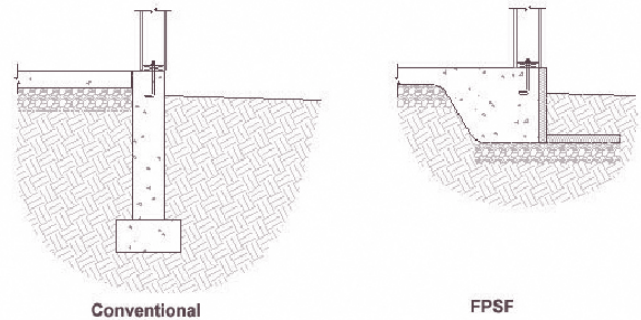

Resources:

- NAHB Research Center, Revised Guide to Frost-Protected Shallow Foundations www.toolbase.org/docs/SubsystemNav/Foundations/4495_RevisedFPSFGuide.pdf

2.2 ENHANCE DURABILITY AND REDUCE MAINTENANCE

Intent:

Building designs, material choices, and installation techniques should seek to minimize the effects of degradation and weathering, enhance life expectancy of the assembly, and lessen maintenance needs.

Information / How to Implement:

Durability may be defined as the ability of a material, product, or building to maintain its intended function for its intended life expectancy with intended levels of maintenance in intended conditions of use.

Fortunately, many of the best practices meant to improve durability require little more than good judgment and a basic knowledge of the factors that affect building durability. A thorough review of resource publications will provide a solid foundation.

Resources:

- NAHB Research Center for PATH, Durability by Design, www.huduser.org/publications/destech/durdesign.html
- Canadian Architect, *Measures of Sustainability*, www.cdnarchitect.com/asf/perspectives_sustainability/measures_of_sustainability/measures_of_sustainability_durability.htm
- The Residential Moisture Management Network is working on addressing issues related to moisture management in homes, www.rmmn.org/
- Installation details for wood framed construction that will minimize moisture intrusion into the building envelope can be found at www.buildabetterhome.org. Publications on foundations, roofs, and walls can be downloaded by going to each of those sections under the “builder tips” and then clicking on “get the brochure.”

2.2.1 Provide a covered entry (e.g., awning, covered porch) at exterior doors to prevent water intrusion and subsequent rotting of joists, sills, and finishes.

Intent:

A roof over an entry to a home sheds precipitation and keeps sunlight from the opening, protecting the door finish and penetration of moisture around jambs, trim and threshold, minimizing the need for maintenance of these areas. Roofs over entries also are convenient for the occupant during foul weather and are an architectural feature that can enhance a home’s visual appeal and provide an outdoor living space.

Information / How to Implement:

Designs should include a roof or recessed front opening of a depth equal to or greater than the recommended roof overhang for the region.

Resources:

Information will be added in Version 2.

2.2.2. Use recommended-sized roof overhangs for the climate.

Intent:

Protect the building envelope and enhance the home’s durability through the use of overhangs. Use overhangs to shade windows from summer heat gain.

Information / How to Implement:

The following table presents the recommended roof eave and rake overhangs for varying the climates:

RECOMMENDED MINIMUM ROOF OVERHANG WIDTHS FOR ONE- AND TWO-STORY WOOD FRAME BUILDINGS*

Climate Index (see map below)	Eave Overhang (inches)	Rake Overhang (inches)
Less than 20	N/A	N/A
21 to 40	12	12
41 to 70	18	12
More than 70	24 or more	12 or more

Source: Modification of Prevention and Control of Decay in Homes by Arthur F. Verrall and Terry L. Amburgey, prepared for the U.S. Department of Agriculture and U.S. Department of Housing and Urban Development, Washington, DC, 1978.

* Table based on typical two-story home with vinyl or similar lap siding. Larger overhangs should be considered for taller buildings or wall systems susceptible to water penetration and rot.

Resources:

- NAHB Research Center for PATH, Durability by Design, www.huduser.org/publications/destech/durdesign.html

2.2.3. Install perimeter drain for all basement footings sloped to discharge to daylight, dry well, or sump pit.

Intent:

Divert surface and subsurface water away from the house, and limit water seepage through the foundation walls and basement slab.

Information / How to Implement:

A perimeter footing drain system of perforated pipe should be installed below the level of the basement slab on the inside and outside of the foundation wall and interconnected. Pipe should be wrapped with filter fabric and surrounded with a prescribed minimum of (IRC® 12 inches x 6 inches, exterior) clean gravel or crushed stone. If the outfall is to a sump pit, and the pit requires mechanical removal, pipe should be installed for outfall 10 feet away from foundation wall that does not cause localized erosion.

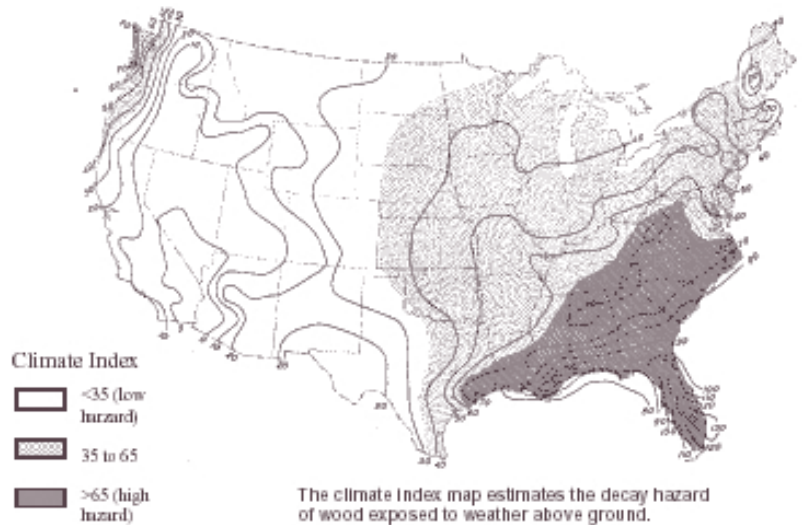

Resources:

Information will be added in Version 2.

2.2.4. Install drip edge at eave and gable roof edges.

Intent:

The drip edge directs roof runoff water into the gutters and away from the fascia and roof sheathing.

Information / How to Implement:

Drip edge is an inexpensive accessory that can be included in the roofer's scope of work and roofing material package.

Resources:

- Truini, Joseph, This Old House, Roof Runoff Remedy, www.thisoldhouse.com/toh/knowhow/solutions/article/0,16417,193154,00.html

2.2.5. Install gutter and downspout system to divert water at least five feet away from foundation and into the overall onsite drainage area.

Intent:

Moisture intrusion of foundations is avoided by moving runoff water beyond the foundation.

Information / How to Implement:

Storm water can be diverted from the roof and into a rain garden. Such a technique can help beautify the yard, reduce the amount of mowing needed, and reduce the need to use potable water for watering.

Resources:

Information will be added in Version 2.

2.2.6 Divert surface water from all sides of building. Slope top of backfill to achieve settled slope of at least six inches of fall within 10 feet of the foundation walls.**Intent:**

Moisture intrusion of foundations is avoided by moving runoff water beyond the foundation.

Resources:

Steven Winter Assoc., Inc. for HUD, Volume 1 Rehab Guide: Foundations, Chapter 4,
www.toolbase.org/docs/SubsystemNav/Foundations/4406_rehab1_found.pdf

2.2.7. Install a continuous and physical foundation termite barrier in areas where subterranean termite infestation is a problem.**Intent:**

Providing a non-chemical termite obstruction offers a long-term solution to termite infestation avoidance.

Information / How to Implement:

IRC Fig. R 301.2(6) has a Termite Infestation Probability Map of the United States dividing the country into different zones of infestation levels; heavy, moderate to heavy, etc. The local HBA may offer information on the regional probability of termite infestation in consultation with the cooperative extension service and other termite experts.

Using a foundation termite shield is only one way a builder can effectively combat infestation. Following is a breakdown of the home building process and a list of the tactics that can be used in an environmentally aware fashion to accomplish termite resistance.

I. Site.

- A. Selection—termites dislike dry conditions. Choose a site that is well-drained and ventilated.
- B. Sanitation—the majority of termites that infest homes live underground, and food (cellulose in the form of wood, paper, leaves, etc.) stored underground may lead termites to a house. When preparing a site for construction, don't bury vegetation and construction debris. After the foundation is built, don't include wood scraps in the backfill.
- C. Landscaping—Keep homes dry. Slope finish grade away from the house. Keep plantings well away from homes. Roots act as underground bridges through chemical or physical termite barriers. Plants such as shrubs and trees can prevent ventilation to the home and prevent drying after precipitation events.

II. Design

- A. Layout—Keep houses dry. Ensure that wood elements are stopped at least eight inches above finish grade. Termites can form hills or tubes that extend from the soil to food. Greater clearance between ground and wood elements prevents this situation and allows more time for detection should termites use tubes to reach above-ground food sources. Keep untreated wood away from contact with concrete. Concrete is a good conductor of water, and untreated wood in contact with concrete may decay or attract termites.
- B. Thermal—Termites love moisture and moisture comes from many sources. Proper design of the exterior envelope will prevent condensation from occurring.

- C. Materials—Areas of the home that are particularly susceptible to moisture, like shower and bath surrounds, should not be detailed with cellulose materials. Penetrations through the foundation, walls, and roof are all vulnerable to moisture intrusion, and care should be taken to minimize them. To protect against foundation penetrations, consider using one of new physical barriers in the marketplace. Termiticides bonded between a polymer fabric and a stainless-steel mesh small enough to keep out termites are some of the innovations available.

III. Construction Process

- A. Material Storage—Keep moisture-sensitive materials dry, and don't incorporate compromised products into the house. Arrange to have materials delivered as close to the time of installation as practical.
- B. Flashing—Penetrations through the exterior envelope are particularly vulnerable to moisture intrusion. Properly flash and seal all penetrations to prevent moisture accumulation.

IV. Post Construction

- A. Owner Education—Inform homeowners about the value of dry homes and practices they can perform to keep the house free of termites and decay. Describe prevention features of the home and how these features can become compromised.
- B. Termite Control—Should termites need subsequent control, consider targeted poisons such as baits.

Resources:

- Canadian Wood Council, Termite Control and Wood-Frame Buildings: Slab and Foundation Details, www.cwc.ca/publications/building_performance/termites/structural.php
- NAHB Research Center, Termite Baiting www.toolbase.org/tertiaryT.asp?TrackID=&CategoryID=1402&DocumentID=2153
- University of Kentucky Entomology, Termite Baits: A Guide for Homeowners, www.uky.edu/Agriculture/Entomology/entfacts/struct/ef639.htm
- Termiticide fabric and mesh manufacturers, www.impasse.com/ and <http://www.termi-mesh.com/>

2.2.8. Use termite-resistant materials for walls, floor joists, trusses, exterior decks, and other exterior wood in regions known to be termite infested.

Intent:

By eliminating the cellulose food source for termites or by repelling termites, the home's durability is enhanced.

Information / How to Implement:

Use the IRC® infestation map referenced in Section 2.2.7 to determine the probability of infestation for the region. Termite-resistant materials include naturally pest-resistant species of wood (e.g., redwood, cedar, white oak, black locust), treated wood (borate or ground contact solutions), masonry, steel, and concrete.

Reduce humidity in crawl spaces. Keep shrubs, vines, and other vegetation from growing over ventilation openings. Never bury wood scraps or waste lumber in the yard. Remove old tree stumps and roots around and beneath the building. Inform the homeowner to keep firewood piles away from the house, raised off the ground, and covered.

Resources:

- Durable-Wood.com, Forintek Canada Corp., Termite Control and Wood-Frame Buildings durable-wood.com/termites/termitecontrol-e.pdf
- Western Wood Preservers Institute, www.wwpinstitute.org
- *Terminate the Termites*, www.steel framingalliance.com

2.2.9 Provide a weather-resistant barrier (WRB) or a drainage plane system behind the exterior veneer system or the exterior siding.

Intent:

To protect the building envelope from water intrusion by installing a secondary, exterior-wall water management system.

Information / How to Implement:

Wind-driven rain and air pressure differentials allow water intrusion into and behind most exterior claddings and veneers. A comprehensive approach to water management prevents water from reaching the sheathing or framing. Primary water management strategies include water-shedding architectural features such as overhangs and exterior claddings. Secondary (redundant) water management to protect the sheathing and framing from moisture damage can be in the form of a weather-resistive barrier, a distinct drainage plane, or both.

As part of a whole-wall design, weather-resistant barriers need to be integrated with other wall system components, including structure, insulation, vapor retarder, air retarder (if separate), and flashing systems.

Resources:

- NAHB Research Center, Weather-Resistant Barriers, www.toolbase.org/docs/MainNav/MoistureandLeaks/3950_weatherresistantbarriers.pdf

2.2.10. Install ice flashing at roof edge.

Intent:

The eave edges of a roof are particularly susceptible to water intrusion from wind-driven rain, clogged gutter backup, and freeze-thaw cycles after winter snowfalls. Ice barrier or flashing is a redundant barrier that protects the sheathing near the roof edges and keeps water out of the attic and walls.

Information / How to Implement:

The IRC® requires that, in areas where the average daily temperature in January is 25°F or less, an ice barrier consisting of at least two layers of underlayment cemented together or a self-adhering polymer modified bitumen sheet that extends from the edge of the eave to a point at least 24 inches inside the exterior wall line of the building be installed. It is recommended that the ice barrier approach be used for green home construction because the redundant protection provided by an ice-barrier is effective against many weather phenomena such as rain storms with high winds and winter snow.

Resources:

- University of Minnesota Extension Service, Ice Dams, www.extension.umn.edu/distribution/housingandclothing/DK1068.html

2.2.11 Install enhanced foundation waterproofing.

Intent:

To keep moisture out of the foundation by providing a waterproof exterior coating or engineered exterior drainage plane.

Information / How to Implement:

Foundation coatings that are required by the model building codes help prevent moisture from penetrating the foundation. A number of products are available to provide a more permanent barrier to moisture at the exterior of the foundation.

Resources:

- ToolBase Services, Foundation Drainage Panels, www.toolbase.org/tertiaryT.asp?TrackID=&DocumentID=2063&CategoryID=1010

2.2.12 Employ and show on plans the following flashing details:

- Around windows and doors,
- Valleys,
- Deck/house juncture,
- Roof/wall junctures, chimney step flashing, and
- Drip cap above windows and doors.

Intent:

To specify and call out the details of systems integration on the blueprints rather than leaving them to the half dozen or so specialists who perform installation of adjacent materials on the jobsite. All junctions of dissimilar material and flashing details are to be shown on plans.

Information / How to Implement:

Product manufacturer's installation guides and association best practices details are good sources for the correct detailing of systems.

Resources:

- Brick, www.gobrick.com/html/frmset_thnt.htm
- Masonry products, www.ncma.org
- Various, <http://pix.nrel.gov:8020/BASIS/nich/www/bapublic/SDF>
- Windows and doors, <http://pix.nrel.gov:8020/BASIS/nich/www/bapublic/SDF>
- Wood, <http://apacad.org/>
- *EEBA Water Management Guide*—www.eeba.org/mall/water.asp—This guide presents a variety of ways to minimize water intrusion into homes. These recommendations are not intended to apply to every conceivable situation but are intended to illustrate principles.

2.3 REUSE MATERIALS**2.3.1 Disassemble existing buildings (deconstruction) instead of demolishing.****Intent:**

Construction activities may comprise as much as 40% of all raw materials extracted from the earth. At the same time, construction, remodeling, and deconstruction are blamed for generating 136 million tons of waste annually. Some waste material can easily be refitted into a structure. The action decreases both material use and waste. In addition, unneeded transportation costs associated with hauling can be eliminated.

Information / How to Implement:

Develop and implement a plan to use materials prudently, regardless of their origination.

Resources:

- Inform, Inc., *Community Waste Prevention Toolkit: Construction and Demolition Fact Sheet*, www.informinc.org/fact_CWPconstruction.php#basics
- Government of Hawaii, *Minimizing Construction and Demolition Waste*, www.hawaii.gov/health/environmental/waste/sw/pdf/constdem.pdf
- California Integrated Waste Management Board (CIWMB), www.ciwmb.ca.gov
- CIWMB, *Recycled-Content Product Directory*, www.ciwmb.ca.gov/RCP/Product.asp?VW=CSI&CATID=269
- NAHB Research Center, ToolBase Services, *Construction Waste Management*, www.toolbase.org/secondaryT.asp?TrackID=&CategoryID=34
- Whole Building Design Guide, *Construction Waste Management Database*, www.wbdg.org/ccbref/cwm.php
- Washington State Department of General Administration, *Construction Waste Management Guide*, www.ga.wa.gov/EAS/CWM/ContractorsGuide.doc

2.3.2 Reuse salvaged materials, where possible.

Intent:

To minimize the waste stream by reusing materials. Ideally, salvaged materials should be reclaimed from a nearby or onsite demolition or remodeling project to minimize transportation.

Information / How to Implement:

Note: Building materials can come from the deconstructed building in 2.3.1 or from another source.

Note—The word “component” is used in certain line items in this section (2.3.2; 2.4.1; 2.5.3; 2.6.1; 2.6.2; 2.7.1; and 2.8.1). A component is defined as part of an entire building system, such as:

- | | | |
|-----------------------|--------------------|-----------------|
| • footing | • wall sheathing | • interior trim |
| • foundation walls | • roof sheathing | • flooring trim |
| • slab | • wall insulation | • finish trim |
| • floor framing | • attic insulation | • siding |
| • interior partitions | • windows | • other. |
| • wall framing | • interior doors | |
| • roof framing | • exterior doors | |

Salvaged materials can be used for fill material, base for paved areas, or within building(s). Materials include crushed concrete, salvaged wood, steel, brick, and architectural materials such as windows, doors, paneling, and cabinets.

Salvaged windows and exterior doors should not be used at the expense of energy efficiency.

Disclaimer—Salvaged materials must meet minimum standards where applicable. Be careful of lead paint and other potentially hazardous finishes that could be part of existing materials.

Points can be provided if the total cost of the salvaged materials (including material costs and labor costs, i.e., installed costs) is equal to or greater than 1% of construction costs.

Resources:

- Jennifer Corson, *The Resourceful Renovator: A Gallery of Ideas for Reusing Building Materials* (Chelsea Green Publishing Company, December 2000)

- Greater Vancouver Regional District Policy and Planning Department, *Old to New Design Guide Salvaged Building Materials in New Construction* 3rd Edition (January 2002), www.buildsmart.ca/pdfs/DesignGuideMaster.pdf
- Used Building Materials Association, <http://bcn.boulder.co.us/environment/ubma/index.html>

2.3.3 Dedicate and provide onsite bins and/or space to facilitate the sorting and reuse of scrap building materials.

Intent:

This practice will establish a central storage area to encourage maximizing usage of all materials on the site. Workers are less likely to waste material that will be subject to future inspection. Those same workers are more likely to seek and use scraps if they know where to find them quickly and the remnants that were not incorporated into the job are already sorted for grinding or recycling.

Information / How to Implement:

Information will be added in Version 2.

Resources

Scopes of work should include the removal of remnants to a designated central area. The reuse area should be conveniently located and marked or delineated for the size, type, and quantity of material expected.

2.4 USE RECYCLED-CONTENT MATERIALS

2.4.1 Use recycled-content building materials.

Intent:

To minimize the impact of home building on the environment.

Information / How to Implement:

Points: To obtain the three points, the project must have a minimum of two types of recycled-content materials. Each type of recycled-content material used thereafter would give the project another point each, to a maximum of six points.

A builder can obtain three points by incorporating at least two different types of recycled-content building materials into the home's construction. An additional point is awarded for each additional type of material for a maximum point total of five points.

Post-consumer means that the materials have been used by a consumer. Post-industrial can include waste materials from within a manufacturing site that are fed back into the manufacturing process as feedstock *and* materials from outside the plant that are waste elsewhere, have not gone to a landfill or consumer yet, but are incorporated into a product's manufacturing process (e.g., fly ash for concrete).

The results of a California Integrated Waste Management Board (CIWMB) study on building material emissions indicate that recycled-content products perform about the same as standard products. Both alternative and standard products have the potential to emit chemicals of concern. For a copy of the study, see www.ciwmb.ca.gov/Publications/GreenBuilding/43303015.doc.

Here are some typical ranges of recycled content found in various construction materials:

Clay brick is manufactured with a variety of recycled materials. Examples include contaminated soils, scrap soils from excavations, inclusion of bottom ash from coal-fired generators, and production scrap from other ceramic products. The amount of recycled materials in clay brick depends on the type of material added, but typical values range up to 7% by weight.

Through the Composite Panel Association's Environmentally Preferable Product (EPP) Specification CPA 1-02, composite panels (particleboard, medium-density fiberboard [MDF], and hardboard) can be certified to have 100% recycled or recovered fiber. See the Resources section of this line item for further information.

Cellulose insulation can contain as much as 85% recycled paper stock (wood-based) content. Additionally, it is certified in accordance with ASTM 739 and the Cellulose Insulation Manufacturers Association.

Fiberglass insulation: 25% combination post- and pre-consumer recyclables

Steel framing: 25% of which no less than 10% should be post-consumer recycled

Carpeting: Recycled-content carpet is available for residential construction



Fly ash or slag: Fly ash or slag, by-products of the steel production process, can be used in concrete as a replacement for some of the cement. In some cases, as much as 40% of the cement can be substituted while maintaining required strength and durability. Many concrete suppliers are familiar with recycled-content options, and some have reported that the use of fly ash or slag is standard practice. Several contractors have reported that the fly ash-content concrete sets up more slowly, and adjustments must be made in the timing of finishing. Also, fly ash- or slag-content concrete may have some dark streaking and therefore, may not be suitable for exposed flatwork or poured walls. Check with your local concrete supplier.

Road and paver base, gravel: In many parts of the country, efforts are underway to recycle concrete waste. Concrete is ground into usable materials for temporary construction roads, a base for pavers or bricks, or other possible uses in place of limestone or gravel. In some cases, concrete suppliers have developed and tested mixes in which some recycled concrete is used. Check with local concrete suppliers or landfills to see if recycled concrete aggregate is available.

Check with local jurisdictions regarding recycling programs. The use of recyclable materials is also recommended. Products that are either recycled or recyclable will display the triangle logo (see above). The product literature must note the recycled content, if any. The reference section contains additional information on this.

Resources:

- King County (WA), *Environmentally Responsible Carpet Choices*, www.metrokc.gov/procure/green/carpet.htm
- U.S. Environmental Protection Agency (EPA), *Comprehensive Procurement Guidelines*, www.epa.gov/cpg/
- EPA, *Environmentally Preferable Purchasing*, www.epa.gov/oppt/epp/tools/toolsuite.htm
- Green Building Source, *Green Product Information* <http://oikos.com/products/index.lasso>
- California Integrated Waste Management Board, *Recycled Product Directory*; *Products Category: Construction*, can provide a baseline for total recycled content (TRC) that is achievable with some products, www.ciwmb.ca.gov/RCP/Product.asp?VW=CAT&CATID=257
- Details on the Composite Panel Association's Environmentally Preferable Product (EPP) Specification CPA 1-02 and a list of certified manufacturers, www.pbmdf.com/AboutCPA/EPP.asp
- Carpet America Recovery EffortSM, www.carpetrecovery.org/
- Steel Recycling Institute, www.recycle-steel.org/construction.html

Excerpt from the Federal Trade Commission's Part 260 —*GUIDES FOR THE USE OF ENVIRONMENTAL MARKETING CLAIMS*... (d) Recyclable: "It is deceptive to misrepresent, directly or by implication, that a product or package is recyclable. A product or package should not be marketed as recyclable unless it can be collected, separated or otherwise recovered from the solid waste stream for reuse, or in the manufacture or assembly of another package or product, through an established recycling program. Unqualified claims of recyclability for a product or package may be made if the entire product or package, excluding minor incidental components, is recyclable. For products or packages that are made of both recyclable and non-recyclable components, the recyclable claim should be adequately qualified to avoid consumer deception about which portions or components of the product or package are recyclable. Claims of recyclability should be qualified to the extent necessary to avoid consumer deception about any limited availability of recycling programs and collection sites. If an incidental component significantly limits the ability to recycle a product or package, a claim of recyclability would be deceptive. A product or package that is made from recyclable material, but, because of its shape, size or some other attribute, is not accepted in recycling programs for such material, should not be marketed as recyclable..."

Source: Federal Trade Commission, Part 260—Guides for the Use of Environmental Marketing Claims, www.ftc.gov/bcp/grnrule/guides980427.htm

2.5 RECYCLE WASTE MATERIALS DURING CONSTRUCTION

Recycling waste materials is driven by market conditions at the local level. Recycling markets and tipping fees vary greatly.

2.5.1 Develop and implement a construction and demolition (C & D) waste management plan that is posted at job site.

Intent:

Create a C & D waste management plan that sets goals to recycle or salvage a minimum of 50% (by weight) of construction, demolition, and land-clearing waste.

Information / How to Implement:

A C & D plan can be a simple spreadsheet that covers the materials used or deconstructed on site and the plan for reusing them onsite or recycling them. If recycling, include the name of the hauler, the destination, and approximate quantities. A sample plan can be obtained from the City of Oxnard, CA, in the Resources.

Resources:

- City of Oxnard (CA), C & D *Solid Waste Management and Recycling Plan*, www.ci.oxnard.ca.us/pubworks/refuse/worksheets/c_dplan.pdf
- NAHB Research Center, Inc., Residential Construction Waste information, www.epa.gov/epaoswer/non-hw/debris/mgmt.htm
- U.S. Environmental Protection Agency Solid Waste and Emergency Response, Building Savings, Strategies for Waste Reduction of Construction and Demolition Debris from Buildings (EPA-530-F-00-001) (June 2000), www.epa.gov/osw
- Institute for Local Self-Reliance. www.ilsr.org/recycling/buildingdebris.pdf

2.5.2. Conduct onsite recycling efforts, e.g., use grinder and apply materials onsite, thus reducing transportation-related costs.

Intent:

Through grinding, divert from the landfill a minimum of 50% (by weight) of construction, demolition, and land-clearing waste. Reduce transportation-related environmental costs.

Information / How to Implement:

This task may also be part of the builder C & D plan. Grinding and other methods of onsite processing and reuse of waste require an economic analysis. Large home builders have reported successful integration of a grinder into field operations. (See Waste Handling Equipment news article in References.) For small-volume builders, it not likely be cost effective to own or rent grinding equipment. There may, however, be a local business that could efficiently perform this service for a small job.

Resources:

- Waste Handling Equipment News, Major Home Builders Benefit from On-site Recycling, www.wastehandling.com/july/major.html
- NAHB Research Center, ToolBase Services, RESIDENTIAL CONSTRUCTION WASTE: FROM DISPOSAL TO MANAGEMENT, www.toolbase.org/tertiaryT.asp?TrackID=&CategoryID=34&DocumentID=2301

2.5.3 Recycle construction waste offsite, e.g., wood, cardboard, metals, drywall, plastics, asphalt roofing shingles, concrete, block, other.**Intent:**

Through a recycling program, divert from the landfill a minimum of 50% (by weight) of construction, demolition, and land clearing waste.

Information / How to Implement:

At least two types of materials must be recycled to obtain the six points. Each type of material recycled thereafter yields two points each to a maximum of 12 points.

This task may also be part of the builder C & D plan.

Resources:

- The U.S. General Services Administration (GSA) has recently updated its online Construction Waste Management Database to assist the building industry in reducing construction and demolition waste. Recyclers of construction and demolition waste may advertise their services free on this site. Access the database at <http://cwm.wbdg.org>.
- American Forest and Paper Association, National Wood Recycling Directory, www.afandpa.org/Content/NavigationMenu/Environment_and_Recycling/Recycling/Wood_Recovery1/Wood_Recycling_Directory1/Wood_Recycling_Directory_Intro.htm
- California Integrated Waste Management Board, www.ciwmb.ca.gov/
- Corrugated Packaging Council, How to Recycle Corrugated, <http://cpc.corrugated.org/Recycle/RecyHowTo.aspx>
- U.S. Environmental Protection Agency Municipal and Industrial Solid Waste Division Office of Solid Waste, Characterization of Building-Related Construction and Demolition Debris in the United States (EPA530-R-98-010) (June 1998), www.epa.gov/epaoswer/hazwaste/sqg/c&d-rpt.pdf
- Steel Recycling Database, www.recycle-steel.org/database/main.html

2.6 USE RENEWABLE MATERIALS**2.6.1 Use materials manufactured from renewable resources or agricultural by-products such as soy-based insulation, bamboo, or wood-based products.****Intent:**

Use building products that use carbon sequestration, i.e., that are made from plants that take carbon from the atmosphere and store it as fiber.

Information / How to Implement:

A builder can obtain three points for this line item by incorporating at least two different types of renewable resources into the home's construction. An additional point can be obtained for each additional type of material for a maximum total for this line item not to exceed five points.

Careful review of the material manufacturer's claims and material specifications is required for this task. Points should be given for each material specified and used.

Note: Products used should also comply with the Indoor Environmental Quality section of the User Guide. For example, composite wood or agrifiber panel products should not contain process-added urea-formaldehyde resins or must be third-party certified for low formaldehyde emissions. Particleboard, medium-density fiberboard (MDF), and hardwood plywood substrates must be certified to low formaldehyde emission standards ANSI A208.1, ANSI A208.2 and ANSI/HPVA HP1, respectively (see Section 5.1.5). Similarly, bamboo flooring manufacturers should produce a copy of the lab test results, by an American laboratory, for their products. The results should include a formaldehyde test and a hardness and stability (expansion/contraction) test.

Resources:

Information will be added in Version 2.

2.6.2 Use certified wood for wood and wood-based materials and products from all credible third-party-certified sources.**Intent:**

Preserving our natural resources includes the commitment to best practices in forest management, like practices that maintain and restore their health and ecosystems. Forest certification systems help identify producers that assure a reliable supply without damaging forests.

Information / How to Implement:

A comparison list of the North American certifiers is provided by the Forest Certification Resource Center in the Resources section.

Below is a list of the third-party-certified wood sources.

- The Sustainable Forestry Initiative® Program
- The American Tree Farm System®
- The Canadian Standards Association's Sustainable Forest Management System Standards (CAN/CSA Z809)
- Forest Stewardship Council (FSC)
- Program for the Endorsement of Forest Certification Systems (PEFC), and
- Other such credible programs as they are developed and implemented.

Resources:

- Forest Certification Resource Center, *Comparison of Forest Certification Systems*, www.certifiedwood.org/search-modules/compare-systems/comparison-of-systems/comparison-of_systems.htm
- The Sustainable Forestry Initiative® Program, www.aboutsfi.org/
- The American Tree Farm System® www.treefarmssystem.org/
- The Canadian Standards Association's Sustainable Forest Management System Standards (CAN/CSA Z809) www.sfms.com/welcome.htm
- Forest Stewardship Council (FSC) www.fsc.org/fsc
- Program for the Endorsement of Forest Certification Systems (PEFC) www.pefc.org/internet/html

2.7 USE RESOURCE-EFFICIENT MATERIALS

2.7.1 Use products that contain fewer resources than traditional products.

Intent:

Minimize the resources consumed by and the environmental impact of building a house.

Information / How to Implement:

A project must use resource-efficient materials for at least two different types of components to receive the three points.

When specifying materials, consider the amount of resources going into the product and whether alternatives are available. Examples are specifying hollow brick that meets the requirements of ASTM C 652 and is made from less material than face brick meeting ASTM C 216. Appearance and durability requirements are identical. Or, specifying engineered-wood products, e.g., I-joists that use 35% less fiber material than solid-sawn products.

Caveat: Even though engineered products can reduce the amount of feedstock used in a product, e.g., wood fiber in I-joists, more energy or binders may be needed to create the final product. While this may be the case, our intent is to reduce the core source of material going into the product's creation.

Resources:

- DOE's Energy Efficiency and Renewable Energy, Energy and Environmental Guidelines for Construction, www.eere.energy.gov/buildings/info/design/construction.html#construction

2.8 INNOVATIVE OPTIONS

2.8.1 Use locally available, indigenous materials.

Intent:

To make the home building process more environmentally acceptable by minimizing transportation and processing costs and using materials that are common to the local region.

Information / How to Implement:

A builder can obtain three points for this line item by incorporating at least one type of locally available, indigenous material into the home's construction. An additional point can be obtained for each additional type of material for a maximum point total of five points.

Guidance to program administrators: Points should be awarded in this section based on criteria such as 10% of the building materials are extracted, processed, and manufactured within a 300-mile radius or within a 1000-mile radius if shipped by rail, or a combination of the two distances.

Resources:

Information will be added in Version 2.

2.8.2 Use a life-cycle assessment (LCA) to compare the environmental burden/effects of building materials. Based on the analysis, choose the most environmentally preferable product for that building component.

Intent:

To highlight the best use of resources, including cost, to assure that all of the guiding principles have been considered.

Information / How to Implement:

A life cycle assessment (LCA) is a reliable way to calculate and compare the cradle-to-grave environmental effects and costs of common building materials. Designers can use modeling tools such as Athena™ to examine the life-cycle environmental effects of a complete structure or of individual assemblies, and can experiment with alternative designs and material mixes to arrive at the best environmental footprint. A software tool such as BEES (www.bfrl.nist.gov/oe/software/bees.html) can also identify the life-cycle costs of select building components. The objective of the modeling is to aid the designer in selecting building assemblies and/or materials with the lowest reported impact in terms of energy consumption, air and water toxicity index, GWP, ecologically weighted resource use, and solid-waste emissions.

Suggested course of action:

1. Develop building design using materials with a low environmental impact. Evaluate building materials for each life-cycle phase using either the manufacturer's data or a reputable LCA.
2. Establish a process to compare and assess similar building materials in similar categories.
3. Survey manufacturers to analyze the environmental impacts at each phase of a product's life, making it possible to explore the environmental effects of design options or material mixes in order to arrive at the best green design.
4. Use the Athena™ tool to assess building assemblies.

Another suggested two-step process:

1. Conduct preliminary research and an evaluation of building materials generically, such as concrete, steel, and wood. Explore the environmental effects of different design options or material mixes.
2. Provide evidence that the selection of the foundations and floor assembly materials, structural system (column and beam, or post and beam combinations), roof and envelope assembly materials (cladding, windows etc.) included a life-cycle assessment.

Resources:

- National Institute of Standards and Technology, *Building for Environmental and Economic Sustainability software*, www.bfrl.nist.gov/oe/software/bees.html
- The Athena™ Sustainable Materials Institute, www.athenasmi.ca/news/download/LCI_Database_Project_News_1.pdf

3.1 IMPLEMENT AN INTEGRATED AND COMPREHENSIVE APPROACH TO ENERGY-EFFICIENT DESIGN OF BUILDING SITE, BUILDING ENVELOPE, AND MECHANICAL SPACE CONDITIONING SYSTEMS

Intent:

To use a whole-systems approach in designing and building an energy-efficient home. Key concepts are integrated and comprehensive.

Information / How to Implement:

Pay attention to multiple facets related to energy efficiency during the design and construction process. For instance, rather than simply focusing on individual decisions related to energy efficiency, such as the R-value of attic insulation, consider the implications of each choice on the performance of the whole house. Balance the cost and performance of each component of the home system, such as a well-insulated building envelope (foundation, walls, and attic); windows recommended for the climate by experts such as the Efficient Windows Collaborative, the Department of Energy, and/or local energy professionals; a thorough and carefully implemented air sealing package; climate-appropriate heating and cooling equipment that balances efficiency with cost-effectiveness; sealed ductwork kept within the conditioned space; and efficient water heating equipment and distribution. Moisture and indoor environmental quality are closely related factors that are affected by energy-efficiency measures.

For more detailed information and explanation about the sizing and design of space heating and cooling, refer to “Understanding HVAC System Design Issues” at the end of this Energy Efficiency section.

Resources:

- *Home Energy Checklist* (EEBA) www.eeba.org/technology/publications/hec/default.htm
- *Whole House Energy Checklist* (U.S. DOE fact sheet), www.southface.org/web/resources&services/publications/technical_bulletins/WH-Energy%20Checklist%20CO-10099-766.pdf
- *Energy Efficiency Pays* (U.S. DOE fact sheet), www.southface.org/web/resources&services/publications/technical_bulletins/EEP-Efficiency_pays%2099-746.pdf
- *Considerations for Building a More Energy Efficient Home*, NAHB Research Center fact sheet. Available at www.toolbase.org/tertiaryT.asp?TrackID=&CategoryID=1809&DocumentID=4168

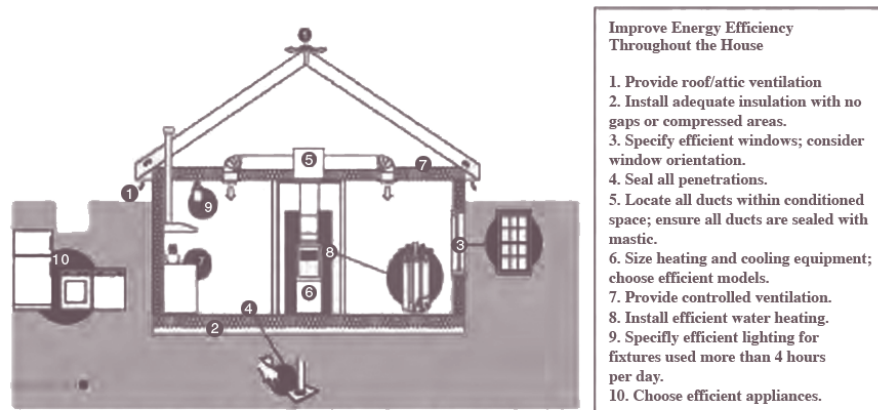

Courtesy of Southface Institute: developed with funding from the U.S. Department of Energy

Requirements:

- 3.1.1 Home is equivalent to the IECC 2003 or local energy code whichever, is more stringent. Conformance shall be based on plan analysis using software such as REScheck or other as approved by green building program administrator or NAHB.**
- 3.1.2 Space heating and cooling system/equipment shall be sized according to building heating and cooling loads calculated using ANSI/ACCA Manual J 8th Edition or equivalent. Computerized software recognized by ACCA as being in compliance with Manual J 8th Edition may be used.**
- 3.1.3 Conduct third-party plan review to verify design and compliance with Section 3. When multiple homes of the same model are to be built by the same builder, a representative sample of homes (15%) may be reviewed subject to a sampling protocol.**

Intent:

To establish a minimum energy threshold for all NAHB-certified green homes

Information / How to Implement:

If you are building under the jurisdiction of the 2003 International Energy Conservation Code (IECC), your home will meet this requirement. If you do not follow the IECC 2003, you can determine if your project meets this energy code by using REScheck, a free, easy-to-use software package.

Resources:

- **REScheck** is a free software tool that can be downloaded at www.energycodes.gov/rescheck/.
- **Manual J 8th Edition** is available through the Air Conditioning Contractors of America and can be purchased online at www.accaconference.com/Merchant2/merchant.mvc?Screen=SFNT&Store_Code=ACCOA. Also, see www.acca.org for additional approved third-party software providers.
- *Heat Loss Calculation Guide H-22*, Hydronics Institute Division of GAMA, 2001
- *International Energy Conservation Code (IECC) 2003*. Available from the International Code Council, www.iccsafe.org
- Third-party plan review: A Certified Home Energy Rating System (HERS) rater. A directory of Home Energy Raters can be found on the ENERGY STAR® website at www.energystar.gov.

3.2 PERFORMANCE MEASURES

Optional guidelines—At least 37 points must be obtained from the line items under the Energy Efficiency section to qualify your project as a green home at the Bronze level. The Silver level requires 62 points and the Gold level 100 points.

3.2.1 Home is X % above IECC 2003:

- A. 15%
- B. 30%
- C. 40%



Intent:

To offer builders a flexible, performance-based means of achieving higher levels of energy performance than the IECC 2003. An ENERGY STAR home is approximately 15% more energy efficient than a home that meets the IECC 2003. Some builders are now achieving a 40% or 50% improvement.

Information / How to Implement:

Use REScheck to examine the effect of different levels of insulation, window U-values and SHGC factors, and space conditioning equipment efficiencies to identify a cost-effective system for your project. The appropriate level of energy performance above IECC 2003 will vary depending upon the severity of the climate, but building to the equivalent of ENERGY STAR is usually cost-effective for consumers in most regions of the country.

Resources:

- REScheck—REScheck, available for free download at: www.energycodes.gov/rescheck/
- International Energy Conservation Code (IECC) 2003. Available from the International Code Council, www.iccsafe.org

3.3 PRESCRIPTIVE PATH

Alternate method for gaining points for energy efficiency

3.3.1 BUILDING ENVELOPE

A. Increased effective R-value of building envelope using advanced framing techniques, continuous insulation, and/or integrated structural insulating system.

Measures may include but are not limited to:

- SIPS*
- ICFs*
- Advanced framing
- Insulated corners and interior/exterior wall intersections*
- Insulated headers on exterior walls
- Raised heel trusses
- Continuous insulation on exterior walls, cathedral ceiling, attics

* This line item also has a resource-efficiency benefit

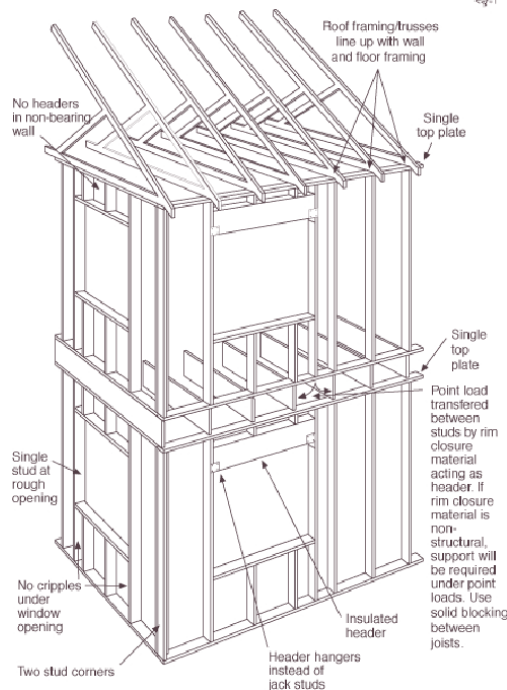
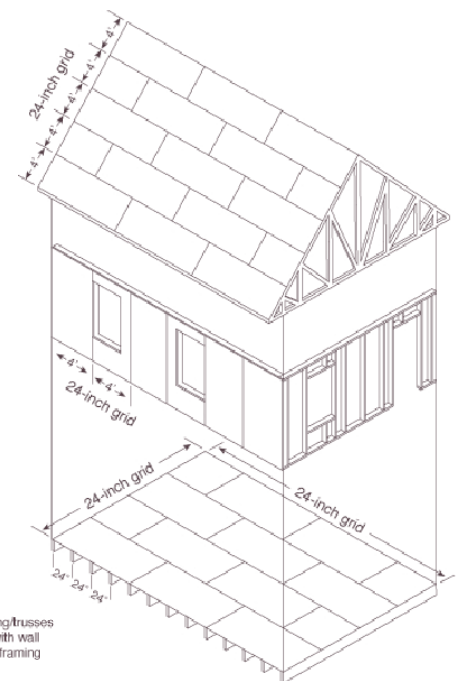

Intent:

To enhance the insulating value of the building envelope by selecting an efficient and cost-effective framing package or alternative structural wall system. Framing details such as two-stud corner framing, ladder blocking at wall intersections, and raised heel roof trusses can eliminate thermal bridges, i.e., areas where there is no room for insulation.

Information / How to Implement:

The Resources listed below will help identify methods for insulating walls to the fullest extent and avoiding thermal bridging.

Resources:

- *Reduce Framing Costs with Advanced Framing Techniques*, U.S. EPA: www.energystar.gov/ia/partners/bldrs_lenders_raters/downloads/BuilderGuide3D.pdf
- *Advanced Framing Fact Sheet*, U.S. DOE: www.toolbase.org/docs/MainNav/WoodFrameConstruction/3949_advancedwallframing1.pdf
- Advanced framing: www.buildingscience.com/housethatwork/advancedframing/default.htm
- *Cost Effective Homebuilding: A Design and Construction Handbook*, 1994, NAHB Research Center, available for purchase at www.nahbrc.org/tertiaryR.asp?TrackID=&DocumentID=2584&CategoryID=917

B. Incorporate air sealing package to reduce infiltration. (All measures that apply to project must be performed.)

- Use sill sealer between foundation and sill plate.
- Caulk bottom plate of exterior walls.
- Air seal band joist cavities between floors.
- Ensure air barrier continuity at all framed cavities such as air chases, soffits, coffered or dropped ceilings, and behind tub/shower units on exterior walls.
- Caulk/foam all electrical, plumbing, heating penetrations between floors (including attic, basement, crawl space, and garage) and to exterior.
- Block and seal cantilevered floors and kneewalls.
- Weatherstrip attic hatches, kneewall doors.
- Insulate, caulk, or foam between window/door jambs and framing.
- If installing recessed lights in ceilings adjacent to unconditioned space, use rated, air-tight Type IC housings.
- Caulk/foam HVAC register boots to subfloor or drywall that penetrate the building envelope.
- If a fireplace is installed, install a sealed-combustion gas fireplace that is sealed combustion or a wood-burning fireplace with gasketed doors.

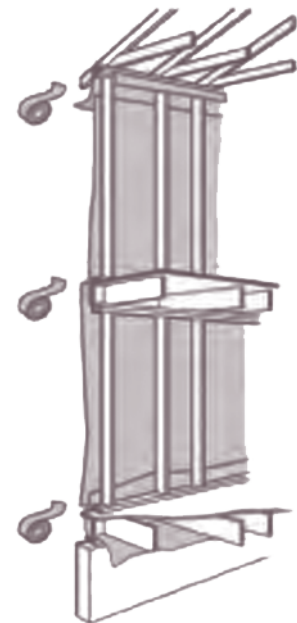

Housewrap Installation

Intent:

When building an energy-efficient home, it is equally or more important to prevent air infiltration as it is to provide a high R-value wall system. Air can pass through very small cracks, resulting in energy loss and condensation, so it is necessary to be very detail-oriented when it comes to air sealing.

Information / How to Implement:

See also Section 5.2.2, *Indoor Environmental Quality* section for more information about mechanical ventilation options.

Air leakage can account for as much as 20%-30% of energy loss through the building envelope. Although insulation reduces energy loss, air infiltration can compromise the efficiency of a building because it brings conditioned air directly outdoors (or outdoor air inside), bypassing the insulation. In addition, it not only carries heated (or cooled) air to the outdoors, but may also create moisture problems as water vapor in the air moves from a warmer to colder location and condenses. Use the list above to make sure that you seal the nooks and crannies where air may escape.

To perform air sealing, use a variety of materials such as caulk, foam, and gasket materials. It has been proven that “chinking” with fiberglass insulation does not prevent airflow. Low-expanding foams should be used around windows and doors so that the frame doesn’t bind—a common complaint with first-generation, high-expanding foam products.

In conjunction with implementing an air sealing package, consider a means of providing fresh air to the home. This may be operable windows if the homeowner will use them, but often an automatic mechanical means of introducing fresh air may be the most reliable way to ensure adequate ventilation. Controlled ventilation that is carefully designed and installed provides a more consistent rate of air exchange compared with simply building a leaky structure. A tight building envelope with an intentional means of introducing outdoor air enhances energy efficiency, comfort, and indoor air quality. See the Indoor Environmental Quality section for additional information about mechanical ventilation.

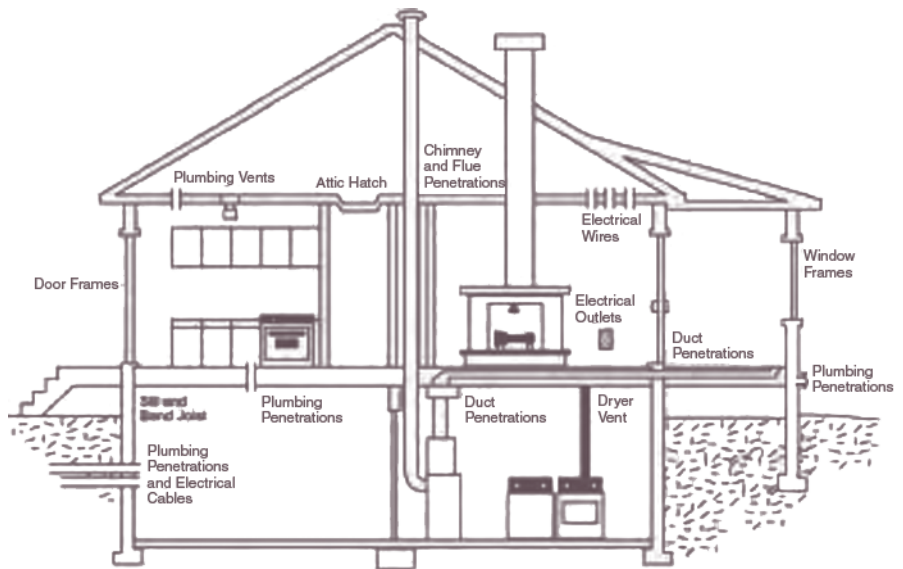

Typical Locations of Air Leakage

Resources:

- *Advanced Air Sealing* (book available for viewing online): <http://oikos.com/library/airsealing/index.html>
- U.S. DOE’s fact sheet, *Airtight Drywall Approach* (no diagrams), www.eere.energy.gov/consumerinfo/fact_sheets/bd8.html
- Southface Energy Institute’s fact sheet, *Airtight Drywall Approach* (contains diagrams), www.southface.org/web/resources&services/publications/fact_sheets/24ada_drywal.pdf



C. Use ENERGY STAR-rated windows appropriate for local climate.

Intent:

To assure optimum building envelope performance. Window area often comprises a substantial portion of the wall area in new homes. Compared with an opaque insulated wall, windows offer only about 15% to 25% of the R-value. In addition, they are a source of direct solar gains in the summer, which can add to the cooling load.

Information / How to Implement:

Select windows featuring the ENERGY STAR label. Alternately, visit the Efficient Windows Collaborative Web site to see which type of glazing is recommended for your climate. Low-E coatings for windows are recommended for almost all regions of the United States. Generally, look for windows with as low a U-value as is affordable—they offer the best insulating value (U-value is the inverse of R-value). In cooling-dominated climates, use a window that has a low SHGC. Always choose a frame that provides a thermal break, e.g., wood, composite, vinyl, or aluminum with a thermal break. Using high-efficiency windows can not only enhance thermal performance but also reduce the risk of condensation on windows. For passive solar designs and homes that are constructed with large amounts of glazing in a specific orientation, use windows selected for each orientation (e.g., high SHGC on south face for direct solar gain). Refer to the Resources for a more detailed understanding of how window technologies perform in various climates.

Resources:

- www.efficientwindows.org
- *Improve Energy Efficiency with High Performance Windows*, ENERGY STAR fact sheet, www.energystar.gov/ia/partners/bldrs_lenders_raters/downloads/BuilderGuide3E.pdf

- Efficient Windows Collaborative, www.efficientwindows.org. Recommends U-value and solar heat gain coefficient (SHGC) by climate region.
- ENERGY STAR website www.energystar.gov for list of stores that sell ENERGY STAR-labeled windows
- The National Fenestration Rating Council (NFRC) labels windows for U-value and solar heat gain coefficient and has searchable directory of windows meeting specific criteria on its web site at www.nfrc.org.

3.3.2 HVAC DESIGN, EQUIPMENT, AND INSTALLATION

A. Size, design, and install duct system using ANSI/ACCA Manual D® or equivalent.

Intent:

Getting the proper amount of airflow to and from each room is as important to comfort and efficiency as the equipment itself. Careful sizing and layout according to recognized industry standards is essential.

Information / How to Implement:

Ask your HVAC contractor to use ACCA Manual D to size and lay out supply and return ductwork to each area of the home. Manual D recommends duct diameter to fit the load in each room, taking into account the length of the duct run and the type of duct being used. Request a copy of the Manual D printout. After the system has been installed, examine it to verify that it is in accord with the design and that there are no sharp bends or poor connections.

Resources:

- *ACCA Manual D®*, Residential Duct Systems (available for purchase at www.acca.org)
- *Air Distribution System Design* (U.S. DOE fact sheet)
www.toolbase.org/docs/MainNav/Energy/4074_doe_airstributionsystemdesign.pdf
- *A Builder's Guide to Placement of Ducts and HVAC Equipment in Conditioned Spaces*, 2000, NAHB Research Center. Available for \$5 from NAHB Research Center bookstore at <http://nahbrc.org/tertiaryR.asp?TrackID=&DocumentID=2570&CategoryID=110>
- *Design and Construction of Interior Duct System*, Florida Solar Energy Center, (2002)
www.fsec.ucf.edu/bldg/baihp/pubs/Papers/interior_ducts.pdf

B. Design radiant or hydronic space heating systems using industry-approved guidelines, e.g., *Guidelines for the Design and Installation of Radiant Panel Heating and Snow/Ice Melting Systems by the Radiant Panel Association, Heat Loss Guide (H-22)*, by the Hydronics Institute Division of GAMA or accredited design professionals and manufacturer's recommendations.

Intent:

To ensure proper design of hydronic and radiant space heating systems by using industry expertise. Hydronic and radiant systems require the same attention to detail as forced air systems. Components such as piping and pumps must be properly sized and matched according to the equipment being used.

Information / How to Implement:

Ask your HVAC contractor to use the Radiant Panel Association design guidelines when designing a hydronic system. There are training and certification programs through the Radiant Panel Association for HVAC contractors

Resources:

- *Quick Reference to RPA Guidelines for Hydronic Radiant Floor Heating, Radiant Panel Association (RPA)*, www.radiantpanelassociation.org/files/public/GdlnQuick.htm. (Entire guidelines available to download for \$15 at www.radiantpanelassociation.org/i4a/store/category.cfm?category_id=8)



- List of RPA certified contractors, available at www.radiantpanelassociation.org

C. Use ANSI/ACCA Manual S® or equivalent to select heating and/or cooling equipment.

Intent:

Manual S is the second step in assuring proper design of a space heating and/or cooling system. After using Manual J to calculate the building's heating and cooling load, use Manual S to help select and size equipment that will satisfy the latent and sensible heating and cooling loads.

Information / How to Implement:

Ask your HVAC contractor to use ACCA Manual S in selecting the heating or cooling equipment for the home. By reviewing this process, you can better understand some of the issues involved and help guide customers' decisions about their heating and cooling system. Very efficient homes that require less energy for heating and cooling are much more sensitive to proper HVAC equipment sizing.

Resources:

- ACCA Manual S®, *Equipment Selection*, available for purchase at www.acca.org
- U.S. DOE fact sheet, Right Size Heating and Cooling Equipment, www.toolbase.org/docs/MainNav/Energy/4073_doe_hvac sizing.pdf

D. Verify performance of the heating/cooling system. The HVAC contractor should perform the following:

- Start-up procedure according to manufacturer's instructions
- Refrigerant charge verified by super-heat and/or sub-cooling method
- Burner set to fire at nameplate input
- Air handler setting/fan speed
- Total airflow within 10% of design flow
- Total external system static should not exceed equipment capability at rated airflow.

Intent:

Verification of performance provides a final assurance that the system has been designed, installed, and commissioned as intended. Items can easily be overlooked during a busy construction schedule, even given the most conscientious approach.

Information / How to Implement:

Ask your HVAC contractor to carefully follow the start-up procedure outlined in the equipment literature. Ask for a checklist of the recommended start-up procedure.

Resources:

- North American Technician Excellence. Operates a certification program for HVAC technicians. Maintains a database of certified technicians at www.natex.org/ or by calling 877-420-NATE.
- Manufacturer's Web site or printed installation instructions

E. Use HVAC installer and/or service technician who are certified under a nationally or regionally recognized program such as NATE, BPI, RPA, or manufacturers' training.

Intent:

The programs cited above are the equivalent of a "technical degree" for an HVAC contractor. With an HVAC trade contractor who has completed a certification, you and your customer can have added assurance that the HVAC system in the home is designed and installed in accordance with the industry's best recommended practices.

Information / How to Implement:

Encourage your contractor to investigate the local availability of HVAC training and certification programs. Ask for certifications when seeking proposals. Some agencies maintain a database of certified contractors; consider using HVAC contractors in your area that have been certified.

At the time of the printing of this document, the Air Conditioning Contractors of America (ACCA) is in the process of establishing a contractor accreditation program that will ensure contractors perform quality installations.

Resources:

- NATEX Business Locator, available at www.natex.org or by calling 877-420-NATE. A searchable database of contractors certified by the National Association for Technician Excellence (NATE).
- The Building Performance Institute. Certifies whole-house performance contractors and provides a searchable database of certified contractors at www.bpi.org.
- List of Radiant Panel Association members that are certified by RPA (for hydronic heating) www.radiantpanelassociation.org
- Manufacturers’ website for directory of contractors trained for proprietary equipment
- The Air Conditioning Contractors of America Web site at www.acca.org

F. Fuel-fired space heating equipment efficiency (AFUE):

		% Improvement above Federal minimum
Gas Furnace	≥81%	3%
	≥88% (ENERGY STAR)	10%
	≥94%	6%
Oil Furnace	≥83%	5%
	Gas or Oil Boiler	5%
	> 90%	10%

 *Note: Add three points associated with increasing AFUE if Manuals S and D and start-up procedure are followed when one of the space heating units noted above is installed.*

Intent:

As with cooling equipment, higher-efficiency equipment will satisfy space heating requirements using less fuel.

Information / How to Implement:

Select equipment bearing the ENERGY STAR label, or check manufacturer’s literature for efficiency information. The American Council for an Energy-Efficient Economy (ACEEE) lists the highest-efficiency equipment available (see Resources). The measure of furnace efficiency, annual fuel utilization efficiency (AFUE), is the ratio of heat produced per unit of fuel consumed over the course of a heating season. Depending upon the fuel used, ask your HVAC contractor about pricing higher-efficiency furnaces or boilers. Typically, 81%-83% of AFUE furnaces carry little cost increase over those meeting federal minimum efficiency standards (currently 78%). Higher-efficiency gas furnaces or boilers (greater than 90% AFUE) are usually direct vent, sealed combustion units and, because the flue gases are cooler, PVC pipe can often be used for venting, eliminating the need for a chimney. Through-the-wall venting may offset the higher cost of the equipment.

Keep in mind that sealed combustion equipment not only offers an energy-efficiency benefit but may also be advantageous with respect to indoor environmental quality as well. The sealed combustion chamber eliminates any possibility of backdrafting or spillage of combustion gases into the home.

It is usually a good idea to invest in high-AFUE heating equipment in climates that have a significant heating load or high fuel costs. Energy-efficiency investment dollars may be better spent elsewhere in cooling-dominated climates.

Resources:

- American Council for an Energy-Efficient Economy’s list of most energy efficient appliances
www.aceee.org/consumerguide/mostenef.htm
- www.energystar.gov for a list of equipment meeting ENERGY STAR standards
- *Gas Appliance Manufacturer’s Consumers’ Directory of Certified Efficiency Ratings for Heating and Water Heating Equipment.* www.gamanet.org
- Manufacturers’ Web sites.

G. Heat pump efficiency (cooling mode)

1. SEER 11-12*—(9%-17% improvement above SEER 10 air conditioner)
2. SEER 13-14—(23%-29% improvement above SEER 10 air conditioner)
3. SEER 15-18—(33% -44% improvement above SEER 10 air conditioner)
4. SEER 19+—(47%+ improvement above SEER 10 air conditioner)
5. Staged air conditioning equipment

Split systems must be ARI-tested as a matched set.

*SEER 13 is the federal minimum as of January 2006.

 **NOTE:** Additional three points given if Manuals S and D have been used and start-up procedures are followed when one of the A/C units noted above is installed.

Intent:

High-efficiency equipment uses less energy to accomplish the same task. The intent of this guideline is to reduce the electrical energy necessary to cool the home.

Information / How to Implement:

Select equipment that carries the ENERGY STAR label, or check manufacturer’s literature for information on SEER. The ACEEE lists the highest-efficiency equipment available (see Resources). Several issues to consider:

As of January 2006, the federal minimum efficiency for air conditioning units is SEER 13.

It is often more beneficial to concentrate on improving design, installation, and commissioning procedures before simply installing equipment with a higher SEER rating. For instance, proper sizing, insulating, and sealing of ductwork can reduce the amount of energy loss and increase occupant comfort as well. Even the most efficient equipment cannot make up for deficiencies in a distribution system or inadequate sizing and commissioning. Before investing in more efficient cooling equipment, invest in proper sizing, design, installation, and commissioning of the entire system.

To encourage such practices, the guidelines award double points for increasing SEER if Manuals S and D and start-up procedures are followed.

For cooling-dominated climates, it often makes sense to invest energy-efficiency dollars in high-SEER equipment. For climates with little cooling load, investments in efficiency may be better spent elsewhere.

Resources:

- List of most energy efficient appliances
- www.aceee.org/consumerguide/mostenef.htm
- www.energystar.gov for a list of equipment meeting ENERGY STAR standards

H. Heat pump efficiency (heating mode)

1. 7.2-7.9 HSPF (6%-16% increase in efficiency)
2. 8.0-8.9 HSPF (18%-31% increase in efficiency)
3. 9.0-10.5 HSPF (32%-54% increase in efficiency)
4. >10.5 HSPF (>54% increase in efficiency)

Intent:

To reduce the amount of nonrenewable energy used to meet the space heating requirements of a home.

Information / How to Implement:

Select equipment that carries the ENERGY STAR label, or check manufacturer's literature for HSPF data. The ACEEE lists the highest-efficiency equipment available (see Resources). The current federal minimum heating season performance factor (HSPF), the standard measure of heat pump efficiency in the heating mode, is 6.8. Heat pumps are often the cost-effective solution for space conditioning equipment in climates where outdoor temperatures are moderate and there is a need for both heating and cooling. Air-to-air heat pumps are not recommended if winter temperatures often drop below 35° F. If heating is the predominant load, consider a heat pump with an HSPF of 8.0 or higher.

Resources:

- American Council for an Energy-Efficient Economy's list of most energy efficient appliances
www.aceee.org/consumerguide/mostenef.htm
- www.energystar.gov for a list of equipment meeting ENERGY STAR standards

I. Ground source heat pump installed by a Certified Geothermal Service Contractor. (cooling mode)

1. EER = 13-14
2. EER = 15-18
3. EER = 19-24
4. EER = > 25

Note: An additional three points are given if Manuals S and D and start-up procedures are followed when one of the ground source heat pumps noted above has been installed. Do not duplicate points if these additional points have been taken in Guidelines 3.3.2.f and 3.3.2.h above.

Intent:

To reduce consumption of non-renewable energy for space heating and cooling requirements and ensure that design and installation are conducted according to industry standards.

Information / How to Implement:

Select ENERGY STAR-labeled equipment, or check manufacturer's literature for EER information. Use a contractor that has been certified in design and installation of geothermal systems by the International Ground Source Heat Pump Association (see Resources)—proper sizing of geothermal systems is crucial for efficiency and to reduce first cost. Ground source heat pumps are often more efficient than air-to-air heat pumps because they take advantage of the constant and more moderate temperature of the ground which is an advantage for space heating in the winter and cooling in the summer. Ground source heat pumps are more expensive to install than air-to-air heat pumps due to the added

cost of drilling wells or trenching for the ground loop. However, they may be cost competitive when compared with very high efficiency furnaces and central air conditioning systems. Geothermal systems may also include a desuperheater, a device that uses some of the waste energy from the heat pump to pre-heat water for domestic use.

Because the selection of equipment, design of ductwork, and commissioning are integral to efficient performance of the system, additional points will be given if these measures have also been completed.

Resources:

- American Council for an Energy-Efficient Economy’s list of most energy efficient appliances
www.aceee.org/consumerguide/mostenef.htm
- www.energystar.gov for a list of equipment meeting ENERGY STAR standards
- International Ground Source Heat Pump Association (IGSHPA), database of accredited installers and designers of geothermal heat pump systems: www.igshpa.okstate.edu/business_directory/home.html
- J. Ground Source Heat Pump installed by a Certified Geothermal Service Contractor (heating mode)
 1. COP = 2.4-2.6
 2. COP = 2.7-2.9
 3. COP > 3.0

(See Section 3.3.2.I above for more information.)

K. Seal ducts, plenums, and equipment to reduce leakage. Use UL 181 foil tapes and/or mastic.

Intent:

To assure optimum performance of the forced-air space conditioning system by reducing duct leakage.

Information / How to Implement:

Leaking Ducts can reduce the heating and cooling efficiency of a forced-air system by as much as 30%. While duct leakage to the conditioned space does not compromise energy performance as does leakage into unconditioned spaces, it may result in a less comfortable space due to insufficient air delivery. Best industry practice is to seal all ductwork with a foil tape meeting UL 181 requirements or with mastic. It is also important to seal plenum connections at the equipment as well as holes in the fan cabinet. Gasketed cabinet doors allow for a tight seal without compromising ease of maintenance. An achievable goal is to strive for less than 5% leakage (as a share of the air handler capacity) to unconditioned space.

Resources:

- Air Distribution System Installation and Sealing, (U.S. DOE fact sheet),
www.toolbase.org/docs/MainNav/Energy/4071_doe_airstributionsysteminstallation.pdf
- Source of supply for duct mastic: Oikos.com has a list of manufacturers of Duct Mastic (category 15816)
- Advanced Air Sealing (book available for viewing online): <http://oikos.com/library/airsealing/index.html>
- Overview of sealing ductwork: <http://energyoutlet.com/res/ducts/index.html>

L. When installing ductwork:

1. No building cavities used as ductwork, e.g., panning joist or stud cavities.
2. Installation of all heating and cooling ducts and mechanical equipment within the conditioned building envelope.
3. No ductwork installed in exterior walls.

Intent:

The possibility of duct leakage to unconditioned space is significantly reduced by avoiding placement of ducts in areas listed.

Information / How to Implement:

Panned joists or stud cavities should be avoided because they can rarely be effectively sealed. When cavities are used as returns, air may be pulled from unintended locations in the home and create unwanted pressure imbalances that may compound energy loss. When cavities are used as supplies, the volume of delivered air may be inadequate, and, because these areas may be dusty and dirty, indoor environmental quality issues may result.

Methods for keeping ductwork in the conditioned envelope include extending the thermal boundary by insulating the foundation walls, insulating the attic at the roof, or installing ductwork beneath an insulated ceiling and enclosing it with bulkheads.

With improved window technology and air sealing practices, there is less need to supply warm air along exterior walls—a common practice in older homes that needed airflow near windows to prevent condensation on poorly insulating windows and to keep occupants warm near drafty windows. In tightly sealed and well-insulated homes, heating or cooling registers can be located near the interior, thereby minimizing duct length and eliminating any need to run ductwork in outside walls. This not only reduces leaking to the exterior but also eliminates the need to reduce insulation in those wall cavities.

Resources:

- *A Builder's Guide to Placement of Ducts and HVAC Equipment in Conditioned Space*, 2000, NAHB Research Center. Available for purchase at www.toolbase.org/tertiaryT.asp?TrackID=&DocumentID=2570&CategoryID=110

M. Install return ducts or transfer grilles in every room having a door except baths, kitchens, closets, pantries, and laundry rooms.

Intent:

To prevent pressure imbalances that may occur when there are central return(s) and interior doors are closed. Pressure imbalances can lead to inadequate airflow to a room, which can create uncomfortable conditions.

Information / How to Implement:

Supply and return registers located in every room and sized according to industry standards provide the best assurance that airflow to each room is balanced. However, having supply and return vents in each room increases the installation cost of a forced-air heating or cooling system. Common practice is to locate a single central return on each floor of the home. This method pulls return air from all areas of the home in most cases, but return airflow is restricted when doors are closed. Doors cannot be undercut sufficiently to provide an adequate path for airflow. When return air flow is restricted from a particular room, that area becomes pressurized and air leakage to the outdoors increases. Other areas of the home may become depressurized causing the opposite effect, i.e., outdoor air is drawn through cracks and crevices. Transfer grilles in interior walls are a cost-effective compromise to ensuring that all rooms have adequate supply and return airflow.

Resources:

- ACCA Manual D® Residential Duct Systems

N. Install ENERGY STAR® ceiling fans. (Points per fan)

Intent:

To reduce energy use for space cooling while maintaining comfort.

Information / How to Implement:

A ceiling fan helps occupants feel cooler without lowering a thermostat because it provides convective cooling from the breeze created. Under many conditions, ceiling fans, which use less energy than most light bulbs, will be all that is

required to keep occupants cool, thereby reducing the need for compressor cooling. ENERGY STAR fans produce more airflow per watt than standard ceiling fans due to improved blade design and more efficient motors.

Resources:

- List of ENERGY STAR-labeled ceiling fans (fan only)
www.energystar.gov/ia/products/prod_lists/ceiling_fans_only_prod_list.pdf
- List of ENERGY STAR-labeled ceiling fans (fan and light)
www.energystar.gov/ia/products/prod_lists/ceiling_fans_with_lighting_prod_list.pdf
- List of ENERGY STAR-labeled ceiling fan (light kits only)
www.energystar.gov/ia/products/prod_lists/ceiling_fans_lightkit_prod_list.pdf

O. Install whole-house fan with insulated louvers.

Intent:

To reduce energy use for space cooling while maintaining comfort.

Information / How to Implement:

A whole-house fan can draw outdoor air inside quickly, providing cooling at night and at other times when the outdoor air is cooler than indoors. A whole-house fan can reduce the energy needed for cooling by taking advantage of the “free” cooling from outside air. Usually placed in the ceiling of the top floor of a home, whole-house fans use less energy than a compressor and air handler. One disadvantage of whole-house fans is that they can be difficult to seal off when not in use. Care must be taken in selecting equipment that has an effective insulating enclosure and in designing and installing a custom insulating and weather stripping system for the enclosure.

Resources:

- Home Energy Magazine article <http://hem.dis.anl.gov/eehem/99/990511.html>
- Whole-House Fan: How to install and use a whole-house fan,
www.southface.org/web/resources&services/publications/technical_bulletins/WHF-Wholehousefan%2099-745.pdf

P. Install ENERGY STAR-labeled mechanical exhaust from every bathroom ducted to the outside.

Intent:

To achieve spot exhaust ventilation using highly efficient ventilation equipment.

Information / How to Implement:

ENERGY STAR-labeled fans provide more ventilation capacity at a lower wattage than a standard bath fan. They are also quieter than most standard fans and therefore are more likely to be used. Because of their more efficient blade design and motors, they are more durable and carry longer warranties than standard fans. Most major manufacturers offer an ENERGY STAR model, but in some areas, it may be a special order item.

This guideline also has an indoor environmental quality benefit in that local removal of moisture and humidity is achieved in a more effective and efficient manner.

Resources:

- List of products meeting ENERGY STAR criteria: www.energystar.gov/ia/products/prod_lists/vent_fans_prod_list.pdf
- Spot Ventilation: Source control to improve indoor air quality (U.S. DOE fact sheet),
www.toolbase.org/docs/MainNav/Energy/3947_spotventilation1.pdf

3.3.3 WATER HEATING DESIGN, EQUIPMENT, AND INSTALLATION

A. Water heater energy factor equal to or greater than those listed in the following table.

Size (gallons)	Energy Factor
30	0.64
40	0.62
50	0.60
65	0.58
75	0.56

Size (gallons)	Energy Factor
30	0.95
40	0.94
50	0.92
65	0.90
80	0.88
100	0.86

Size (gallons)	Energy Factor
30	0.59
50	0.55

Intent:

To increase the efficiency of water heating by installing equipment that provides the same amount of hot water for less energy than standard water heating equipment.

Information / How to Implement:

The hot water heater energy rating that is used to compare different water heaters is the energy factor (EF). EF represents the percentage of purchased fuel (electricity, gas, propane or oil) that is used for heating water; it includes losses through the tank as well as flue losses. Electric tanks have a higher EF than fuel-fired heaters since they do not have flue losses. However, electric tanks can be more expensive to operate than fuel-fired tanks.

To select high-efficiency water heating equipment, compare the yellow Energy Guide labels of similar equipment. Review manufacturer’s literature for energy factor information—the EF is not usually prominently displayed on the unit. Alternately, the ACEEE maintains a list of the highest-efficiency water heating equipment (see Resources).

Resources:

- *The Most Energy Efficient Appliances*, (list from Consumer’s Guide to Home Energy Savings), American Council for an Energy Efficient Economy, www.aceee.org/consumerguide/mostenef.htm
- *Gas Appliance Manufacturer’s Consumers’ Directory of Certified Efficiency Ratings for Heating and Water Heating Equipment*. www.gamanet.org
- *Water Heating: Energy-Efficient Strategies for Supplying Hot Water in the Home* (U.S. DOE fact sheet), www.toolbase.org/docs/SubsystemNav/Plumbing/3946_waterheating.pdf



B. Install whole-house instantaneous (tankless) water heater. (Water heater complies with DOE Standard 10CFR430)

Intent:

To reduce energy use associated with water heating by eliminating standby losses that occur with tank heaters.

Information / How to Implement:

Even though newer tank water heaters are better insulated than their predecessors, heat lost from the tank can account for a large portion of hot water energy consumption, especially in homes that use relatively little hot water. By having no reservoir of hot water, tankless water heaters eliminate these standby losses. For gas tankless water heaters, there are similar flue losses to gas tanks. Both electric and gas tankless water heaters have higher energy factors (EF = 0.62 minimum) than most tank water heaters.

Gas, propane, and electric instantaneous water heaters are available. Typically, gas water heaters can heat a larger volume of water each minute than electric heaters and can provide a greater temperature rise for a given flow rate. This can be an important consideration when coincident hot water uses are expected or when high flow rates at hot temperatures are desired. Electric tankless units can achieve about a 77°F temperature rise at 2.5 gallons per minute—which is plenty for a hot shower but it does not leave a lot of extra capacity for simultaneous hot water usage. Gas units will provide greater capacity to allow for simultaneous multiple uses.

All tankless water heaters use large amounts of energy at higher flow rates. These large draws often require a larger-than-normal service entrance for electric units or larger pipe diameter for gas units. Evaluate these differences when comparing installed costs. Although peak demand for space heating and water heating usually do not occur at similar times, your local utility may offer helpful advice regarding peak demand and selection of whole-house water heating appliances.

Resources:

- *The Most Energy Efficient Appliances*, (list from Consumer's Guide to Home Energy Savings), American Council for an Energy Efficient Economy, www.aceee.org/consumerguide/mostenef.htm

C. Insulate all hot water lines with a minimum of one-inch insulation.

Intent:

To reduce energy losses from hot water piping.

Information / How to Implement:

Insulating hot water piping can be beneficial in two ways: 1) losses are reduced as hot water moves through the lines to the point of use, and 2) losses are slowed and may be reduced when hot water sits in the lines between draws. Foam pipe insulation is relatively inexpensive and easy to install. In addition to offering some energy savings, insulating the hot water lines is also likely to add convenience, comfort, and water savings. Hot water will get to the tap more quickly—meaning there is less potential for water to run down the drain while the user waits for it to get hot.

Resources:

- *Water Heating: Energy-Efficient Strategies for Supplying Hot Water in the Home* (U.S. DOE fact sheet), www.toolbase.org/docs/SubsystemNav/Plumbing/3946_waterheating.pdf

D. Install heat trap on cold and hot water lines to and from the water heater (if not integral to the water heater).

Intent:

To minimize energy loss associated with thermo siphoning action from a water heater.

Information / How to Implement:

In the same way that warm air moves toward cooler air and warm air rises, hot water will rise and displace cooler water in the lines leading to and from the heater tank. This thermo siphoning action contributes to heat loss from the tank, and, once the water temperature in the tank has cooled below the thermostat set point, the elements or burner will need to activate to bring the water back up to temperature, even when there is no demand for hot water. Heat traps prevent thermo siphoning. Many new water heaters have integral heat traps; ask your plumber or plumbing materials supplier or check manufacturers’ literature. If heat traps are not integral to the water heater, install them on the inlet and outlet to the water heater.

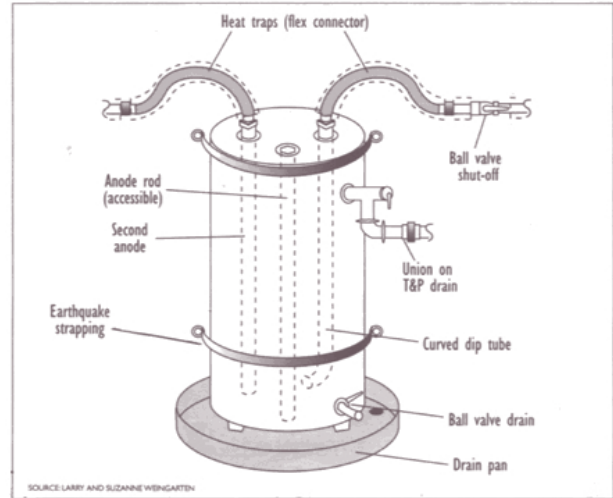

Resources:

- *Water Heating: Energy-Efficient Strategies for Supplying Hot Water in the Home* (U.S. DOE fact sheet)

E. Install manifold plumbing system with parallel piping configuration (aka “home run”) using smallest diameter piping allowed by code.

Intent:

Reduce energy use associated with waiting for hot water at taps and with hot water left standing in pipes after a hot water draw.

Information / How to Implement:

A manifold plumbing system in which dedicated “home run” hot and cold water piping services each fixture allows the most direct (and therefore shortest) pipe run and smaller diameter piping than a “tree” type piping configuration. Reduced pipe diameter means hot water is delivered faster to a faucet and there is less water left in a pipe after a hot water draw—and therefore less energy waste from hot water left to cool in pipes. Most manifold piping is cross-linked polyethylene (PEX) pipe rather than copper or CPVC. Because PEX allows for gentle bends, fittings are reduced, which saves installation time and minimizes the possibility of leaks. Often, three-eighths-inch diameter pipe can be used. PEX also has better insulating value than copper piping. In order to maximize the benefits of a manifold system, baths and kitchens should be located in close proximity to one another and to the water heater.

Resources:

Information will be added in Version 2.

3.3.4 LIGHTING AND APPLIANCES

A. Use an ENERGY STAR Advanced Lighting Package (ALP).

Intent:

To use high-quality, aesthetically pleasing electric light using less energy than conventional incandescent lighting.

Information / How to Implement:

ENERGY STAR fixtures use about two-thirds less electricity than standard fixtures to provide equal light. Although on average, an ENERGY STAR fixture may cost about \$30 more than a comparable standard fixture, the fluorescent bulbs will last longer (about seven years) and cost less to operate over their lifetime than incandescent bulbs. Placing 20

ENERGY STAR fixtures in a home in which electricity costs are 10.5 cents per kWh will reap almost \$100 in annual savings to the homeowner in energy and bulb replacement costs, after accounting for the increase in the mortgage due to higher initial cost. Today’s fluorescent bulbs are dramatically improved over the old technology: Not only are a wide variety of styles available, but the light quality is high and there is no flicker, hum, or delayed start. ENERGY STAR fixtures also carry a two-year warranty.

High-Use Rooms	Kitchen, Dining Room, Living Room, Family Room, Bathroom(s), Halls/Stairway(s)	50% of Total Number of Fixtures
Med/Low-Use Rooms	Bedroom, Den, Office, Basement, Laundry Room, Garage, Closet(s), and All Other Rooms	25% of Total Number of Fixtures
Outdoors	Outdoor Lighting Affixed to Home or Free-Standing Pole(s) Except for Landscape and Solar Lighting	50% of Total Number of Fixtures Including All Flood Lighting

Resources:

- Tool to estimate lighting energy savings of advanced lighting package: www.energystar.gov/ia/partners/manuf_res/Savings_Look-up_ChartsLR.pdf
- ENERGY STAR program information for builders: www.energystar.gov/index.cfm?c=bldrs_lenders_raters.ALP_Builder

 B. Install all recessed lighting fixtures within the conditioned envelope of the building, e.g., fixture housing does not penetrate insulated ceiling.

Intent:

To eliminate energy losses associated with inadequate insulation above, and air infiltration through, light fixtures in insulated ceilings.

Information / How to Implement:

Although there are recessed light fixtures rated for insulation contact, they still carry an energy penalty because of reduced insulation thickness in the ceiling above the fixture and/or air leakage around the housing. To completely avoid this energy penalty, do not install recessed lights in an insulated ceiling. Bulkheads or dropped soffits can permit the installation of recessed lights in insulated ceilings. Be sure that there is a continuous air barrier at the top of the bulkhead or the original ceiling. The preferred method is to install drywall (or other finish material) on the ceiling prior to constructing the bulkhead.

Resources:

Information will be added in Version 2.

C. Install motion sensors on outdoor lighting (if not credited under 3.3.4.a).

Intent:

To minimize outdoor lighting energy use by activating outdoor lighting when needed, rather than operating it continuously.

Information / How to Implement:

Motion sensors activate outdoor lighting only when it is needed: to light an entry as one returns home after dark or to maintain security by illuminating outdoor areas when motion is detected. Many fixtures come with motion sensors, but they can also be installed separately. Not all outdoor ENERGY STAR fixtures have built-in motion sensors.

Resources:

Information will be added in Version 2.



D. Install tubular skylights in rooms without windows.

Intent:

To reduce the need for artificial lighting by providing natural light when available.

Information / How to Implement:

Tubular skylights provide natural lighting to interior spaces while minimizing the inherent energy losses of standard skylights. Tubular skylights have a smaller diameter roof penetration than most skylights and have an additional layer of insulating glazing at the ceiling level.

Resources:

- Tubular Skylights (NAHB Research Center technology fact sheet)
www.toolbase.org/tertiaryT.asp?TrackID=&CategoryID=1282&DocumentID=2024

E. Install ENERGY STAR labeled appliance: Refrigerator, dishwasher, washing machine. (Points per appliance)

Intent:

To reduce energy use in the home for appliances.

Information / How to Implement:

On average, ENERGY STAR-labeled appliances use at least 20% less energy than standard appliances to perform the same duties. ENERGY STAR-labeled dishwashers and washing machines also use less water, which contributes to added resource efficiency. Look for the ENERGY STAR label when selecting major appliances or use the yellow Energy Guide label to compare efficiency of similar appliances.

If you are not directly responsible for the purchase and installation of appliances, you can help customers learn about ENERGY STAR options. It is recommended that points be awarded only if ENERGY STAR appliances are actually installed in the home at the time a project is certified.

Resources:

- www.energystar.gov for list of appliances meeting ENERGY STAR criteria and list of local stores that sell ENERGY STAR appliances. The Web site also includes a calculator to show prospective homeowners how much they will save and how fast the upgraded appliance will pay for itself over time.

3.3.5 RENEWABLE ENERGY/SOLAR HEATING AND COOLING

3.3.5.1 Solar Space Heating and Cooling

More detailed design guidance for climate-specific passive solar design is available from the Sustainable Building Industry Council , 1331 H Street NW, Suite 1000, Washington, DC 20005; Phone: (202) 628-7400; www.sbicouncil.org.

A. Use sun-tempered design: Building orientation, sizing of glazing, design of overhangs to provide shading are in accordance with guidelines below:

- Long side of the home faces within 30° of south;
- Glazing area < 7% of finished floor area (FFA) on south face (Low-E);
- Glazing area < 2% of FFA on west face (Low-E, Low SHGC);
- Glazing area < 4% of FFA on east face (Low-E, Low SHGC);

- Glazing area < 4% of FFA on north face (Low-E);
- Skylights less than 2% of finished ceiling area, with shades and insulated wells;
- Overhangs designed to provide shading on south-facing glass (at a minimum), or adjustable canopies or awnings. (See *User Guide* for charts that indicate length of overhang, amount and period of shading according to latitude.)

Intent:

To reduce the amount of non-renewable energy required to heat and cool a home through design features that permit solar heat gains and minimize the potential for overheating.

Information / How to Implement:

The Sustainable Buildings Industry Council provides the most concise and clear-cut guidance on sun-tempered design. The design rules of thumb cited above will provide some solar benefit and prevent overheating in most climates.

Resources:

- *Green Building Guidelines—Meeting the Demand for Low-Energy, Resource-Efficient Homes*, Chapter 2A: Renewable Energy: Solar and Other Renewables, Sustainable Buildings Industry Council
- *Passive Solar Design Strategies, Guidelines for Home Building*, Sustainable Building Industries Council, www.psic.org
- *Passive Solar Design* (NAHB Research Center fact sheet) www.toolbase.org/docs/MainNav/Energy/3944_passivesolar design.pdf

B. Use passive solar design: Sun-tempered design as above plus additional south-facing glazing, appropriately designed thermal mass to prevent overheating, and provision for airflow to adjoining rooms.

- Sun-tempered design as outlined in Section 3.3.5.1a except additional glazing permitted on south wall PLUS
- For any room with south-facing glazing > 7% of FFA, properly sized thermal mass, and
- Provision for forced air flow to adjoining areas as needed.
- SBIC Passive Solar Design Guidelines for your climate should be referenced to size thermal mass.

Intent:

To reduce the amount of non-renewable energy required to heat and cool a home by taking advantage of the sun's energy through passive design features that collect desirable solar heat gain and mitigate unwanted solar heat gain.

Information / How to Implement:

Note: 3.3.5.1.A must also be implemented to receive points for 3.3.5.1.B.

In most regions of the country having a winter heating load, homes can be designed so a portion of this load is satisfied by solar gains. As south-facing glass is increased to obtain greater solar benefit, thermal mass must be provided to store excess heat gain, prevent overheating, and moderate heat delivery to the home. Properly sized thermal mass (typically in the form of masonry materials such as tile floors and brick walls, or water) absorbs heat while the sun strikes it and releases that heat slowly once the sun has gone down. Designing a truly passive solar home requires careful calculation of solar gain, thermal storage capacity, and hourly outdoor winter conditions. Obtain the passive solar design guidelines (see Resource) for your climate as well as the other references cited below. It is also advisable to consult a design professional with background and experience in passive solar design.

Resources:

- *Green Building Guidelines—Meeting the Demand for Low-Energy, Resource-Efficient Homes*, Chapter 2A: Renewable Energy: Solar and Other Renewables, Sustainable Buildings Industry Council
- Sustainable Building Industry Council Passive Solar Design Guidelines, available at www.sbicouncil.org

C. Use passive cooling.

- Exterior shading on east and west windows, e.g., shade trees, moveable awnings or louvers, covered porches
- Overhangs designed to provide shading on south-facing glazing. (Use supplied charts that indicate length of overhang and amount and period of shading according to latitude. Not to be double-counted if credited in 3.4.1.a above)
- Windows located to facilitate cross ventilation.
- Solar reflective roof or radiant barrier in hot climate.



Intent:

To reduce non-renewable energy required for space cooling in the home by mitigating solar heat gain and using design features that promote natural ventilation.

Information / How to Implement:

Natural features, landscaping, and architectural features can help cool a home naturally and/or reduce unwanted solar gains that increase cooling load. The charts below provide guidance on the length of overhangs to achieve desired shading of south-facing glass for different latitudes in the country.

Shading of east and west windows is difficult to achieve with a fixed overhang because the sun is low in the sky when shading is typically desired. Moveable awnings or louvers allow the flexibility to shade windows during certain times of the day or year. In cooling-dominated climates, a covered porch may be a good solution on the west side of the home to mitigate unwanted solar heat gain.

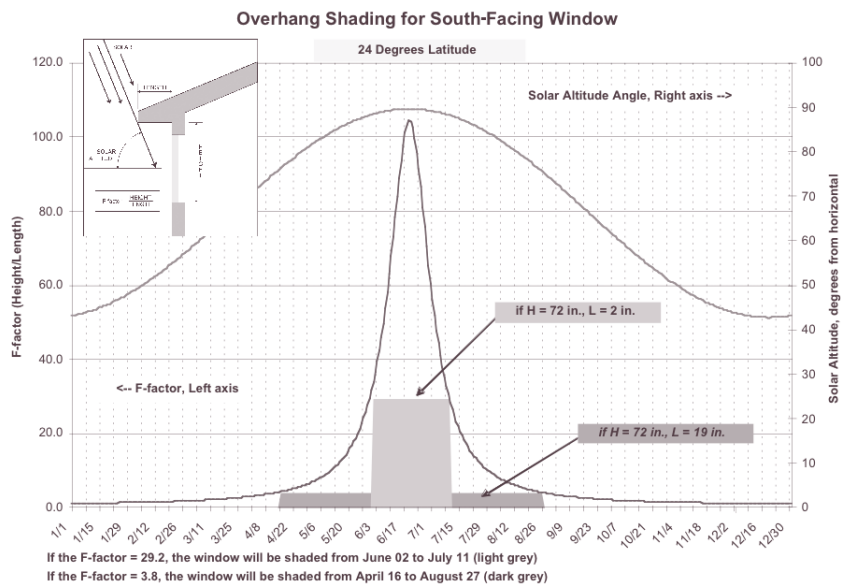

Overhang Shading for South-Facing Window

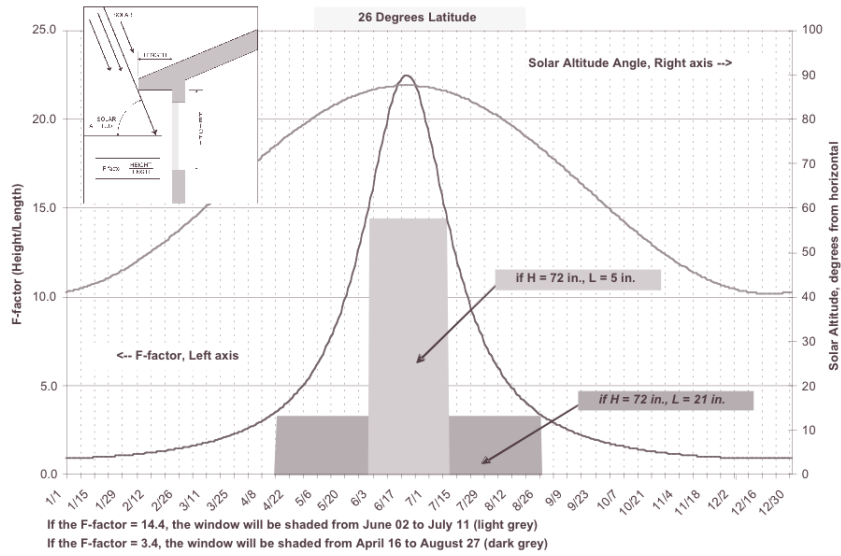

Overhang Shading for South-Facing Window

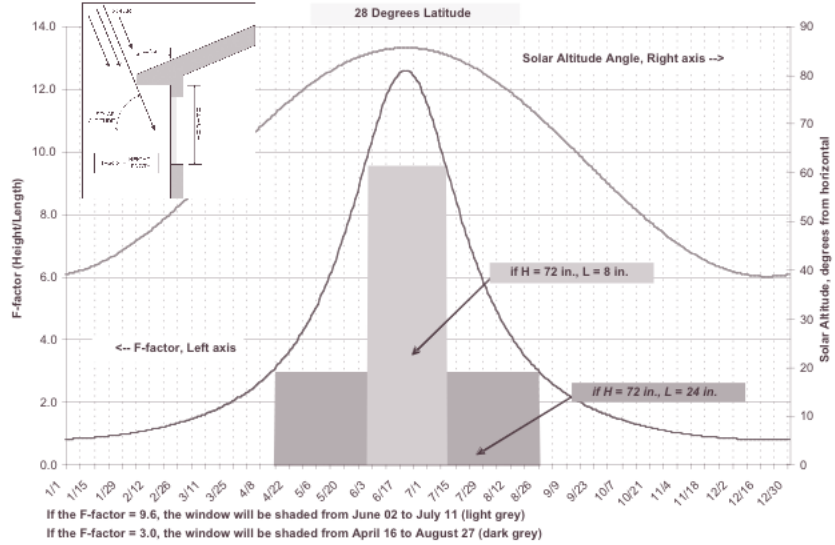

Overhang Shading for South-Facing Window

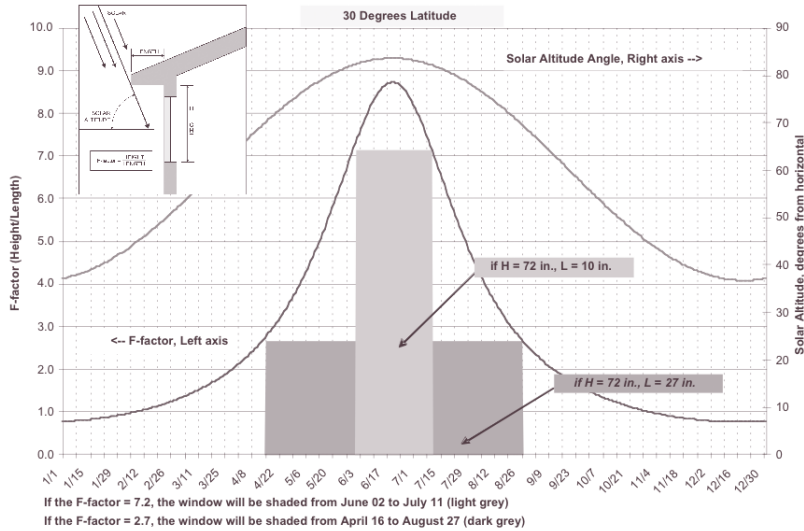

Overhang Shading for South-Facing Window

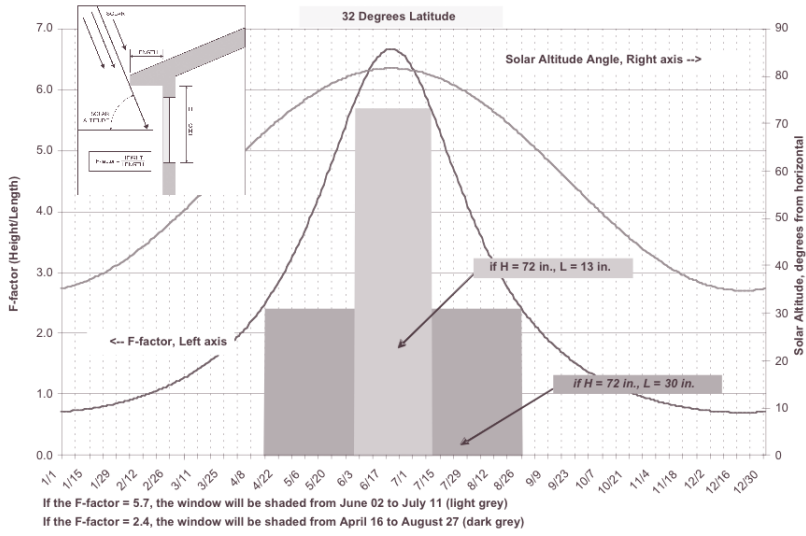

Overhang Shading for South-Facing Window

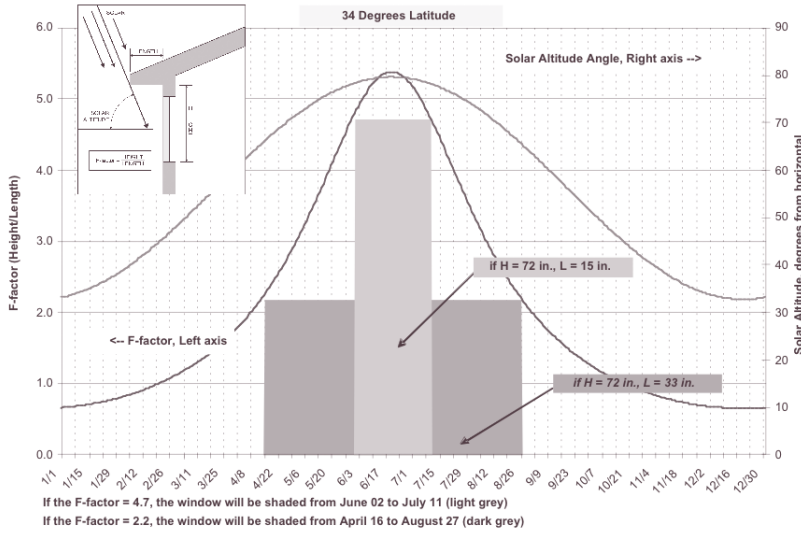

Overhang Shading for South-Facing Window

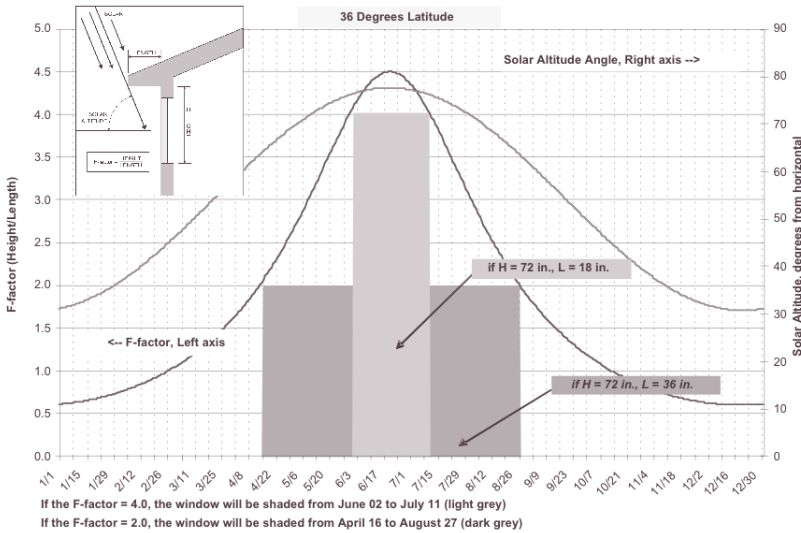

Overhang Shading for South-Facing Window

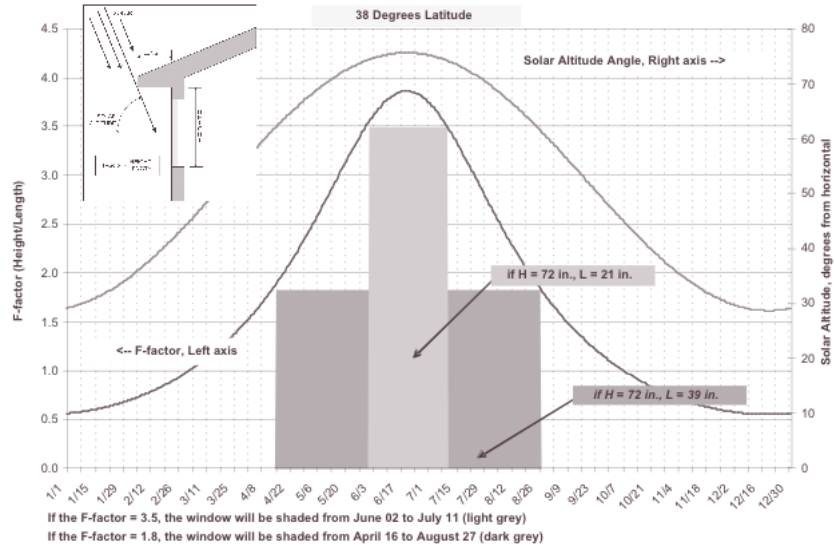

Overhang Shading for South-Facing Window

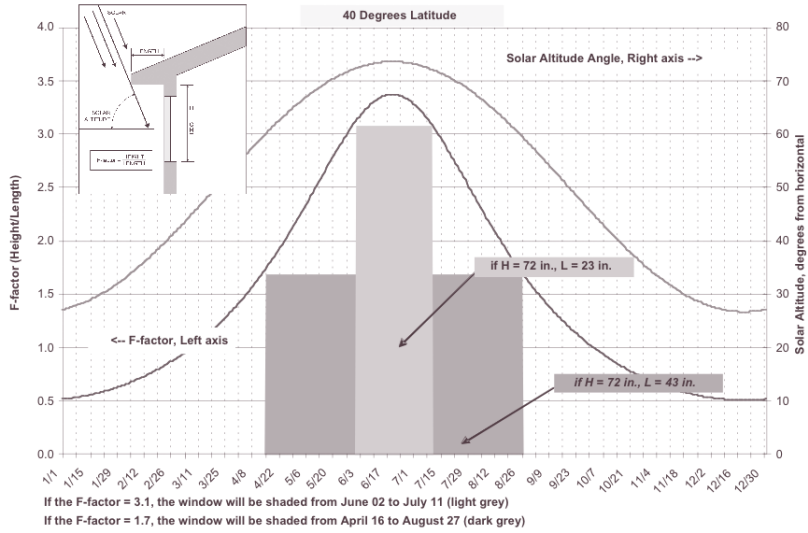

Overhang Shading for South-Facing Window

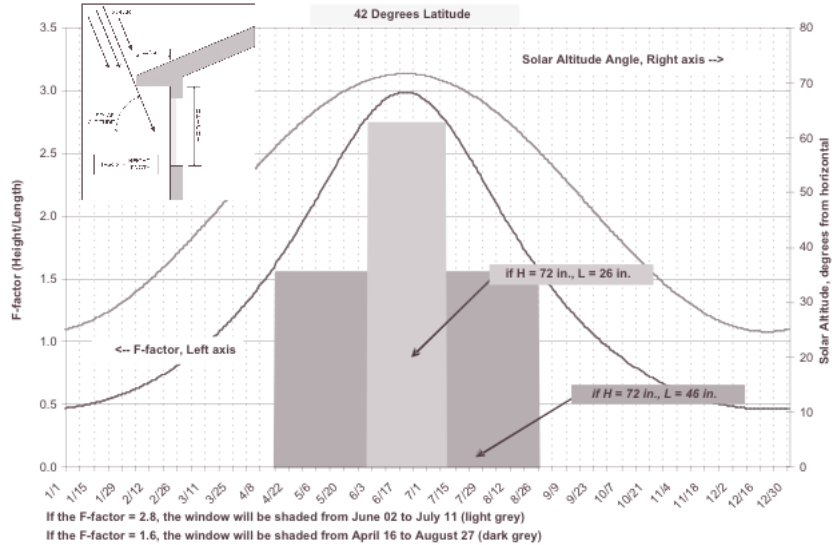

Overhang Shading for South-Facing Window

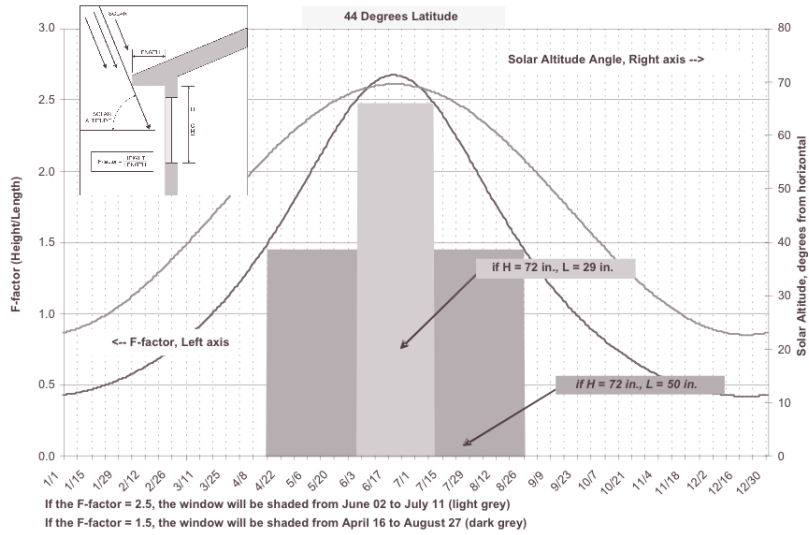

Overhang Shading for South-Facing Window

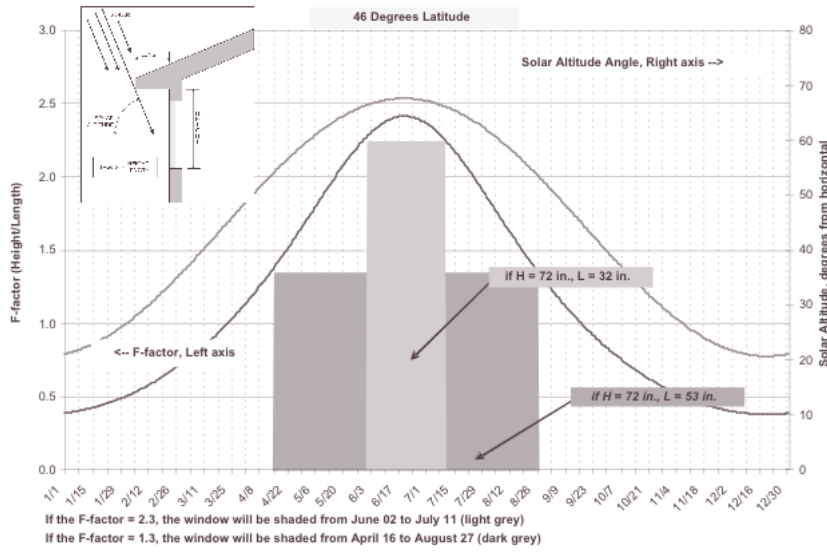

Overhang Shading for South-Facing Window

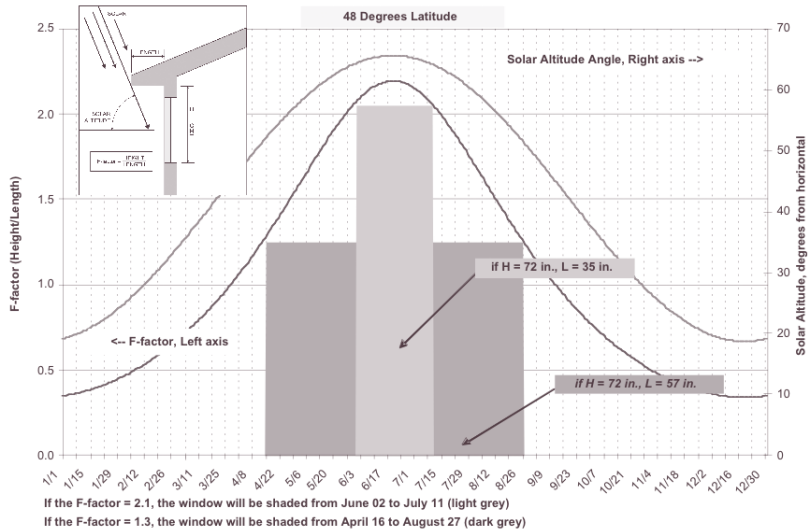

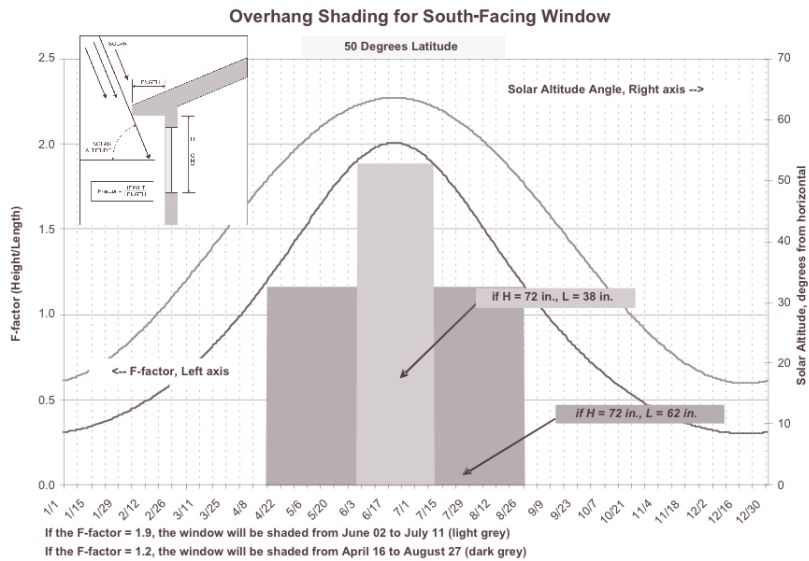

Resources:

- *Passive Solar Heating and Cooling: Natural Cooling*, Arizona Solar Center fact sheet, www.azsolarcenter.com/technology/pas-3.html
- *Cooling Your Home Naturally*, (U.S. DOE fact sheet) www.eere.energy.gov/consumerinfo/pdfs/coolhome.pdf
- *Passive Solar Design Strategies*, Guidelines for Home Building, Sustainable Building Industries Council, www.psic.org

3.3.5.2 Solar Water Heating

A. Install solar water heating system. Must use Solar Rating and Certification Corporation (SRCC)-rated system. Solar fraction:

- 1. 0.3
- 2. >0.5

Intent:

To reduce non-renewable energy use for domestic water heating.

Information / How to Implement:

Solar collectors that preheat water for domestic use are often cost-effective. However, solar water heaters must be designed and installed properly to operate to their maximum potential for many years. Solar water heater designs are generally climate specific, primarily with regard to freeze protection. Consult a knowledgeable local installer to design the system, select equipment, and carefully install the system. Use the references below for a basic understanding of the types of systems available and the estimated performance in your climate. Use the ratings published by the SRCC (see Resources) to determine the solar fraction provided by the system you select.

Resources:

- For a list of Solar Rating and Certification Corporation’s certified solar water heating systems, see www.solar-rating.org
- *Solar Water Heaters* (NAHB Research Center technology fact sheet), www.toolbase.org/tertiaryT.asp?TrackID=&DocumentID=2136&CategoryID=68
- Database of State Incentives for Renewable Energy, www.dsireusa.org

3.3.5.3 Additional Renewable Energy Options

A. Supply electricity needs via onsite renewable energy source such as photovoltaic, wind, or hydro whereby the system is estimated to produce the following kWh per year:

1. 2,000 to 3,999
2. 4,000 to 5,999
3. 6,000 +

 (Equipment should carry all applicable IEEE and UL certifications. Installation shall be in accordance with local utility and electrical code requirements.)

Intent:

To supply a portion of a household's electricity needs with renewable energy sources, reducing peak electricity demand of the home. Peak electricity demand can necessitate power companies to operate peak generation equipment, which, because it is operated for a short time, generally is less efficient.

Information / How to Implement:

As demand for electricity increases and costs to build additional generating capacity continue to escalate, renewable energy sources such as photovoltaics and wind power become more attractive and more cost effective to consumers and utilities. Local generation of electricity by the sun and wind is a viable option in most regions of the country. Costs of smaller (2 kW to 8 kW) photovoltaic systems are about \$8-\$9 per watt, and in some states like New York, California, and New Jersey, incentives are available that bring the cost even lower. Net metering—in which excess electricity produced at a residence causes the electric meter to spin backwards—may also be available in your area. Net metering effectively credits the customer full retail value for electricity sent back to the utility and greatly improves the economics of residential solar electric power production.

Resources:

- www.dsireusa.org—provides information about areas offering incentives that promote renewable energy and information about net metering rules.

B. Provide clear and unshaded roof area (+/-30° of south or flat) for future solar collector or photovoltaics. Minimum area of 200 sf. Provide a rough-in of piping from the roof to the utility area for:

1. Conduit
2. Insulated piping

Intent:

To encourage and facilitate installation of renewable energy systems for space and water heating needs.

Information / How to Implement:

By providing the infrastructure for the installation of a solar thermal collector or photovoltaic system, you can increase the likelihood that the homeowner will install a renewable energy system in the future. Given the uncertainties of the cost of electricity as well as the possibility of eventual incentives, it makes sense to build this flexibility into the home. It is relatively simple and inexpensive to run electrical conduit or water piping to the attic or roof area while the home is under construction but can be disruptive and costly when retrofitted at a later date. This measure contributes to the cost-effectiveness of the installation of a future renewable energy system.

Resources:

Information will be added in Version 2.

C. Provide homeowner with information and enrollment materials about options to purchase green power from the local electric utility. *(Not to duplicate points for Homeowner Manual in IEQ section below.)*

Intent:

To increase the possibility that the homeowner will select green power when available from the local utility.

Information / How to Implement:

Many utilities across the country purchase or produce at least some power from renewable sources such as wind or hydro. Some utilities offer this power to their customers through green pricing programs, in which a customer can choose to purchase a certain amount of electricity generated by renewable sources. While this electricity is usually more expensive than the utility’s standard rates, green pricing programs enable customers to indicate their support for renewable energy sources.

Resources:

- www.eere.energy.gov/greenpower/markets/pricing.shtml?page=0
- Database of State Incentives for Renewable Energy, www.dsireusa.org
- State Energy Office—directory of state energy offices at www.naseo.org/members/states.htm
- Photovoltaics, U.S. DOE fact sheet, www.eere.energy.gov/RE/solar_photovoltaics.html

3.3.6 VERIFICATION

3.3.6.1 Conduct onsite third-party inspection to verify installation of energy related features such as:

- A. Duct installation and sealing
- B. Building envelope air sealing details
- C. Proper installation of insulation including: no gaps, voids, or compression
- D. Batt insulation cut accurately to fit cavity
- E. Windows and doors flashed, caulked, and sealed properly.

(When at least 100 homes of the same model are to be built by the same builder, a representative sample [15%] of homes may be inspected.)

Intent:

The third-party verification of materials and features that enhance energy efficiency offers customers an added level of assurance that the home will perform as designed. Most builders that have used third-party inspections say it is worth the extra cost because it provides proof to potential clients that the home has higher-quality energy features than competitors’ homes.

Information / How to Implement:

A third-party inspection can be performed by any objective, experienced, outside party such as a green building program coordinator, a code enforcement official, an architect or engineer, an energy consultant or specialist, a Home Energy Rating System professional (HERS rater), or an energy program coordinator. Photographs taken by the builder during construction have often been used to defray costs associated with onsite inspections.

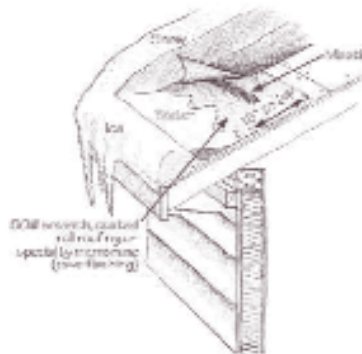

Ice Flashing Detail

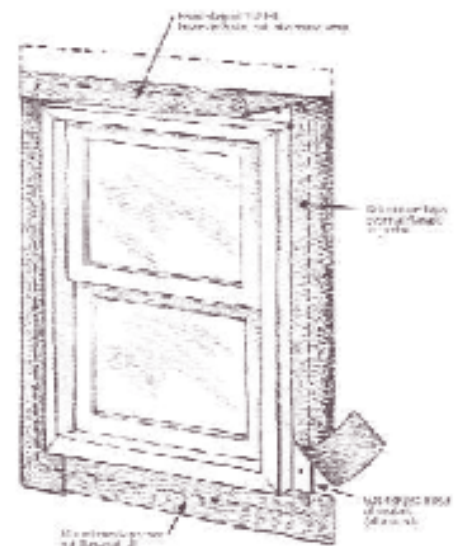

Window Flashing Detail

Resources:

- Third-party plan review using a Certified HERS rater. A directory of home energy raters can be found on the ENERGY STAR website at www.energystar.gov.
- Local utility, if it offers a new-home energy-efficiency program.

3.3.6.2 Conduct third-party testing to verify performance, e.g., blower door, duct leakage, and flow hood testing (points given per test).

A. Building envelope leakage: blower door test results < 0.35 ACHnat

B. Central HVAC duct leakage: Duct leakage test results:

- Leakage to unconditioned space < 5% of rated blower capacity.
- Total leakage < 10% of rated blower capacity.

C. Balanced HVAC airflows: Flow hood test results:

- Measured flow at each supply and return register within 25% of design flow.
- Total airflow within 10% of design flow

(When multiple homes of the same model are to be built by the same builder, a representative sample of homes may be tested subject to the sampling protocol.)

Intent:

Testing of the installed systems of a home such as envelope or duct tightness or airflows of HVAC systems provides an added level of assurance to the customer as well as to the builder that energy features were installed properly and will perform to expected levels.

Information / How to Implement:

Keep in mind that proper design and installation are the key ingredients; testing provides confirmation, assurance, and possibly education. With respect to blower door and duct blaster testing, the builder is able not only to gain an idea of the relative tightness of the envelope or the ductwork but also to identify potential problem areas that need correction. Duct blaster testing is less important when all ducts are located within conditioned space; under these conditions, the test may identify comfort or installation issues rather than energy lost to the outdoors.

Third-party testing is conducted by professionals who have specialized equipment for blower door and duct pressure testing. See Resources for information on finding energy specialists who can conduct testing.

Resources:

- Third-party plan review by a certified Home Energy Rating System (HERS) rater. A directory of HERS raters can be found on the ENERGY STAR website at www.energystar.gov.
- Building Performance Institute (www.bpi.org) certifies whole-house building performance contractors.
- Manufacturers of testing equipment offer databases of contractors trained on proprietary equipment (e.g., The Energy Conservatory)
- Local utility
- Yellow pages for “energy,” “energy efficiency,” or “weatherization”

3.3.7 Innovative options

A. Install drain water heat recovery system.

Intent:

To reduce energy required for heating domestic hot water.

Information / How to Implement:

Drain water heat recovery (DHR) systems recover some of the energy from hot water going down the drain. DHR systems are available from several manufacturers. One type of DHR system, the GFX, consists of flexible copper piping coiled around a copper drainpipe that is fitted into the DWV line with rubber couplings. In a typical GFX configuration, cold water running through the outer flexible copper tubing is preheated by hot water running down the drain from the main shower. The preheated water is then supplied to both the hot water tank and the cold side of the main shower—which reduces the volume and flow of hot water needed. A similar configuration can be designed for the whole house but must be more carefully designed.

Resources:

- Department of Energy—www.eere.energy.gov/consumerinfo/energy_savers/virtualhome/508/shower.html
- Drainwater Heat Recovery, NAHB Research Center technology fact sheet, www.toolbase.org/tertiaryT.asp?TrackID=&DocumentID=2134&CategoryID=947

B. Install a desuperheater in conjunction with ground source heat pump.

Intent:

Increase the efficiency of a ground source heat pump operating in cooling mode while providing “free” hot water for domestic use. Also provide hot water while heat pump is in heating mode at high efficiency.

Information / How to Implement:

A desuperheater recovers heat that is rejected from a ground source heat pump (GSHP) operating in cooling mode, increasing the cooling efficiency of the heat pump and providing “free” hot water. In heating mode, hot water is produced by the GSHP and, therefore, is produced at a high efficiency. Desuperheaters should be installed by an experience installer or come pre-installed from the factory.

Desuperheaters can be an addition to any split system A/C unit but are most commonly found on ground-source heat pump units.

Resources:

- www.energystar.gov/ia/partners/bldrs_lenders_raters/downloads/BuilderGuide3E.pdf
- Improve Energy Efficiency with Desuperheaters, U.S. EPA fact sheet, www.energystar.gov/ia/partners/bldrs_lenders_raters/downloads/BuilderGuide3E.pdf
- Geothermal heat pump manufacturer websites

C. Install heat pump water heater. Must be rated according to the current U.S. DOE test standard and shall have an Energy Factor > 1.7.

Intent:

Reduce the energy needs for electric water heating.

Information / How to Implement:

Heat pump water heaters (HPWH) operate in a similar way to space conditioning heat pumps—they use the energy in the surrounding air to preheat water. HPWH technology has been under development for many years and is now reaching the marketplace with a number of manufacturers offering products. HPWHs operate best in hot climates where the resultant cooling of the air around the heat pump can provide additional energy savings during most of the year. HPWHs can as much as double the efficiency of electric water heating, not including any additional energy savings from space conditioning.

Careful design of the heat pump water heater system is necessary to ensure adequate performance in all seasons.

Resources:

- www.toolbase.org/tertiaryT.asp?DocumentID=2100&CategoryID=946
 - Heat Pump Water Heaters, Federal Technology Alert, List of heat pump water heater manufacturers at ACEEE's Web site: www.aceee.org/consumerguide/topwater.htm
- D. Install occupancy sensors for lighting control. (Points per sensor)

Intent:

Reduce the electricity consumption associated with lighting in unoccupied rooms.

Information / How to Implement:

Purchase lighting controls from a supplier of energy-efficient products or your local lighting supply store.

Resources:

- Retail outlet of energy-efficient products, e.g., www.EFL.org, www.positive-energy.com, www.sheltersupply.com

UNDERSTANDING HVAC SYSTEM DESIGN ISSUES

When designing a comfort system, it is not adequate to merely produce a heat loss and heat gain estimate. Heat loss and heat gain estimates are part of a design procedure that flows from system selection decisions and the actual load calculations to equipment selection procedures, placement and selection of air distribution hardware, duct routing and airway sizing.

Documents such as ACCA Manual RS provide valuable information about zoning, system concepts, equipment capability, and design procedures. It is strongly recommended that system designers be familiar with the material in Manual RS.

Manual J or equivalent load calculations affect every aspect of the system design procedure. The calculations must be as accurate as possible.

- Equipment capacity that matches the size of the applied heating and cooling loads will deliver comfort, efficiency, and reliability over the entire range of operating conditions.
- Heating and cooling loads determine the total air delivery requirement (blower CFM) and the airflow requirement for each room (room CFM). This airflow information is then used to select supply air outlets and to size the duct runs.
- Load information also is used to estimate purchased energy requirements and to estimate annual operating cost. In this regard, the energy and operating cost estimates will only be as accurate as the load estimate.
- The design concept must be suitable for the application:
 - Contemporary architecture tends to produce dwellings that require a zoned system and/or variable capacity equipment.
 - Custom homes that feature a large amount of architectural glass that provides a panoramic view or architectural theme may not have internal shade, or the shading device may be completely open when the room is occupied. In such cases, the performance of the glass (U-value and solar heat gain coefficient) has a significant effect on comfort, equipment size, and energy use. If there is a large amount of south glass, cooling may be required during cold weather. These dwellings must be carefully zoned and may require year-round cooling.
 - People may be uncomfortable when bathed by sunlight pouring through a window. During cold nights or cold overcast days, radiation from the occupant's skin to cold glass surfaces may cause discomfort.
- External overhangs or some type of internal shading device are desirable because they provide comfort for the occupants (overhangs provide shade without interfering with the view).

Manual S (or Equivalent) and Manufacturer's Data to Select Equipment

In general, the effective capacity of heating and cooling equipment shall, as closely as possible, match the load when the equipment is subjected to design conditions. For instance, Manual S explains how to use Manual J output and manufacturer performance data to obtain this result. Manual S also provides guidelines pertaining to the acceptable amount of excess capacity and manipulating heat pump balance points.

ACCA Manual T (or Equivalent) and Manufacturer's Data to Select Supply Outlets and Return Grilles

Supply outlets (grilles and registers) shall be the appropriate style and size for the application and shall be in an appropriate location for the application.

- Supply outlets shall not produce objectionable noise. Design guides and manufacturers' information establish limits for face velocity.
- Supply outlets shall provide the appropriate throw for the installed location. Floor outlets shall throw the supply air to the ceiling; ceiling outlets shall throw the supply air to the wall, etc. Size depends on product performance, the supply CFM value, and the face velocity limitation.
- Never blow supply air directly into the occupied zone. Occupants will complain about drafts.
- Floor outlets that blow air straight up the exposed wall are best for cold-climate heating and, if properly selected, adequate for cooling.
- Ceiling outlets are best for cooling but will not warm slab or exposed floors during the winter.
- If high sidewall outlets are used for cooling, supply air shall not drop into the occupied zone during cooling. These devices will not warm slab or exposed floors during the winter.
- The relation between supply CFM, throw, face velocity, and drop is established by manufacturer performance data. Performance is very sensitive to size, and devices that appear to be generally similar can have substantially different performance characteristics.
- A low-resistance return path shall be provided for every room that receives supply air—a wall opening with no door, a transfer grille, or a ducted return. Door undercuts are not acceptable.
- Return grilles shall be the correct size for the grille flow rate. Filter grilles have a lower face velocity than plain grilles.
- The location of the return grille does not affect room air patterns, which are controlled by the supply outlets and will not have a significant effect on pockets of stagnant air. Low returns do pull warm air down to the floor, and high returns do not pull cool air up into the occupied zone.

Manual D (or Equivalent) to Size the Duct Runs

The resistance (inches water gauge of static pressure) of the longest circulation path (longest supply run plus longest return run) shall be compatible with the performance of the blower that is supplied with the heating-cooling equipment. Airway sizes that are compatible with the blower performance shall be increased if airflow velocity creates a potential noise problem. All systems shall have adequate provision for balancing airflow.

- The length of the longest circulation path and the available static pressure determine the friction rate used for airway sizing.
- The length of the circulation path includes the straight runs and the equivalent length of the fittings along the path. One fitting can add from 5 feet to more than 60 feet to the length of the path.
- External static pressure is determined from the equipment manufacturer's blower performance data, preferably for medium-speed operation.
- The available static pressure equals the external static pressure minus the pressure drop through all the air-side devices in the circulation path. Refer to blower table footnotes and manufacturer pressure drop data for devices that were not in place when blower performance was laboratory-tested by the equipment manufacturer.

- Accessory or after-market filters (or any device) that produce a substantial increase in system resistance shall not be installed if the blower cannot accommodate the increased resistance by speed change. An arbitrary increase in system resistance may cause low airflow to rooms, a high temperature rise across a furnace heat exchanger, or low suction pressure at the cooling coil.
- The room heat loss and heat gain estimate (Manual J or equivalent) and the heating and cooling factors (Manual D or equivalent) determine the design value for room airflow.
- Airway size is determined by sectional flow rate and the design friction rate value.
- The friction chart or duct slide rule used for airway sizing shall be technically correct for the type of duct material.
- Airway velocities shall not exceed specified design limits.
- Branch (runout) ducts shall be equipped with a hand damper (for balancing).

Related Comfort Conditioning System Design Considerations

Impact of Incorrectly Sized Heating and Cooling Equipment

- The obvious problem with significantly undersized equipment is that it will not maintain the desired set-point temperature when a passing weather system imposes a design load on it. However, slightly undersized cooling equipment—by a margin of 10 percent or less—may actually provide more comfort at a lower cost.
- Oversized equipment causes short cycles, marginalizes part-load temperature control, creates pockets of stagnant air (unless the blower operates continuously) and degrades humidity control during the cooling season (more information on this subject is provided below). Oversized equipment also requires larger duct runs, increases installed cost, increases operating cost, increases the installed load on the utility grid, and causes unnecessary stress on the machinery.

Humidity Control During the Cooling Season

- Sensible and latent cooling loads are imposed on dwellings in climates that have a substantial amount of moisture in the outdoor air during the cooling season (wet-coil climates). When the summer design condition occurs, properly sized equipment will operate continuously or almost continuously, both loads will be completely neutralized, and the occupants will be comfortable. But, the design condition occurs for only a few dozen hours per season.
- Reduced latent capacity at part load will cause the indoor humidity to drift above the design value, which is acceptable, providing the relative humidity stays below 60 percent. The possibility for experiencing comfort problems at part-load conditions is minimized by using the default indoor and outdoor design conditions recommended by the design manual, providing a code or regulation does not specify a different set of conditions.
- Some climates are too dry to produce a latent load on the indoor coil. In this case, the indoor humidity depends on the moisture content of the outdoor air, the infiltration rate, and the amount of moisture generated by the occupants. If the outdoor air is very dry, these factors will combine to produce an indoor relative humidity of less than 50 percent and could even be lower than 40 percent. But if the relative humidity stays above 30 percent, the indoor air condition will be in the comfort zone.

Humidity Control During the Heating Season

During the heating season, dry air causes a sensation of coolness, a desire to increase the thermostat set point, problems with static electricity, and dry sinuses. Adding a humidifier to the heating system moderates these problems, but if a humidifier is installed, it must not produce a visible or concealed condensation problem. (See the unabridged version of Manual J for more information on this subject.)

Part-Load Days More Important than Design-Load Days

As a group, homeowners are overly concerned with extreme weather conditions that occur for a few hours per season and uninformed about the significance of the part-load conditions that occur for thousands of hours per season. This lack of understanding pressures contractors to install oversized equipment and results in systems that are more expensive to install, less efficient, less comfortable for a majority of the season, and less reliable. In addition, the oversized equipment produces an unnecessary load on the electric and gas distribution systems. The solution to this problem is consumer education.

4.1 INDOOR/OUTDOOR WATER USE

General Resources:

All aspects of water conservation:
www.awwa.org/waterwiser/

Water Resources of the United States:

<http://water.usgs.gov/>

4.1.1 Hot water delivery to remote locations aided by installation of:

- A. On-demand water heater at point of use served by cold water only. (Points per unit installed)
- B. Control-activated recirculation system.

Intent:

Reduce water waste by using technologies that provide hot water at the tap with a minimal wait time.

Information / How to Implement:

Install a water heater at the point of use, or a hot water recirculation device that is controlled by the user or an automatic device (e.g., timer or thermostat) to minimize or eliminate the waiting period for hot water at faucets. To save both energy and water, recirculating systems should be controlled by the user at the time of use rather than circulating hot water through the piping system continuously. Typically, in this type of controlled system, a switch or a button located near a fixture activates a small pump that begins circulating hot water when there is demand for it.

Resources:

- Demand Hot Water Heater fact sheet:
www.toolbase.org/tertiaryT.asp?TrackID=&CategoryID=1318&DocumentID=3206
- Hot Water Recirculation Systems fact sheet:
www.toolbase.org/tertiaryT.asp?TrackID=&CategoryID=1436&DocumentID=2130
- “An Energy-Saving Product That’s Actually Convenient?” Energy Design Update, July, 1997, pg. 8. This article reviews one hot water recirculation product.

4.1.2 Water heater located within 30 feet pipe run of all bathrooms and kitchen.

Intent:

Minimizing the distance between the water heater and major hot water uses reduces the total amount of plumbing pipe installed. This helps reduce the amount of conductive heat loss from the pipe, the amount of time it takes for hot water to reach baths, the laundry area, and the kitchen (helping to conserve water), and the amount of hot water left standing in pipes after a draw (which helps save energy). It has an added benefit of resource efficiency from using less piping material.

Information / How to Implement:

This line item is closely related to the efficient design of the home discussed under the Resource Efficiency section. The first step in minimizing the distance between the water heater and bathrooms and kitchens is to locate those areas in close proximity to one another when designing a home. Once baths, kitchens, and laundry rooms are “clustered” or “stacked,” the water heater can be placed to maximize efficient delivery. The effective implementation of this line item offers material and labor savings during construction as well as water and energy savings throughout the life of the home.

Resources:

- DOE Technology Fact Sheet—Water Heating www.eere.energy.gov/buildings/info/documents/pdfs/26465.pdf

4.1.3 ENERGY STAR water-conserving appliances installed, e.g., dishwasher, washing machine.

Intent:

Reduce water consumption by selecting water-efficient major household appliances.

Information / How to Implement:

The ENERGY STAR label identifies appliances that are at least 20% more energy efficient than other appliances of similar size and model and use less water than their standard counterparts. An ENERGY STAR washing machine uses approximately 20 gallons of water per load compared with 40 gallons for standard models. The machine also removes more water during the spin cycle, reducing drying time. ENERGY STAR washing machines are available in both top- and front-loading models. An ENERGY STAR dishwasher uses about 40% less water than conventional models. The ENERGY STAR label takes much of the guesswork out of selecting energy efficient appliances and equipment, making the selection process easier for builders and homeowners.

Resources:

- List of ENERGY STAR-rated appliances: www.energystar.gov/index.cfm?c=appliances.pr_appliances
- Vertical Axis (Top Loading) Energy-Saving Clothes Washers: www.toolbase.org/tertiaryT.asp?TrackID=&CategoryID=1280&DocumentID=2004
- Energy Efficient Appliances, DOE Technology Factsheet: www.toolbase.org/Docs/MainNav/Energy/4070_doe_energysavingappliances.pdf?TrackID=&CategoryID=1280&DocumentID=4070
- “Dishing Out Dollars,” *Consumer Reports*, March, 1998, pg. 37. A comprehensive review of energy- and water-efficient dishwashers.



4.1.4 Water-efficient showerhead using conventional aerator or venturi technology for flow rate < 2.5 gpm

Intent:

Save water by installing low-flow showerheads.

Information / How to Implement:

Low-flow showerheads conserve water by cutting water flow to levels below the federal minimum standards for shower-head flow rate.

Resources:

- PATH Technology Inventory: Low Flow Plumbing Fixtures
www.toolbase.org/tertiaryT.asp?TrackID=&CategoryID=1316&DocumentID=2135
- Plumbing materials and supplies: www.plumbingworld.com



4.1.5 Water-efficient sink faucets/aerators < 2.2 gallons/minute

Intent:

Save water by installing aerators that cut flow to levels below the federal minimum standards for faucet flow rate.

Information / How to Implement:

Aerators are a water saving device. Installing aerators in faucets conserves water by restricting the water flow at the faucet outlet. Aerators can be simply screwed into most conventional faucets.

Resources:

- PATH Technology Inventory: Low Flow Plumbing Fixtures
www.toolbase.org/tertiaryT.asp?TrackID=&CategoryID=1316&DocumentID=2135

4.1.6 Ultra-low-flow, (< 1.6 gpm/flush) toilets installed:



- A. Power-assist
- B. Dual flush.

Intent:

Reduce water use associated with toilet flushing.

Information / How to Implement:

Several manufacturers offer toilets that use even less water than the federally mandated 1.6 gallons per flush while still performing reliably. Power-assist toilets with a small, electrically powered pump use either 1.0 or 1.4 gallons per flush depending upon liquid or solid waste. These models require a receptacle near the toilet and have a button on top that allows the user to select the desired flow. One manufacturer estimates water savings of about 2,000 gallons per year. Other new gravity-fed models use as little as 0.8 to 1.4 gallons per flush and maintain quiet operation. Most of these models are set to a particular flow rate at installation, but this setting can be adjusted.

Resources:

- EPA, Low Flow Toilets: www.epa.gov/owm/water-efficiency/toilets.htm
- Arizona Cooperative Extension: www.sahra.arizona.edu/programs/water_cons/home/bathroom_toilet.htm#3



4.1.7 Low-volume, non-spray irrigation system installed, e.g., drip irrigation, bubblers, drip emitters, soaker hose, stream-rotator spray heads.

Intent:

Minimize outdoor water use by installing irrigation systems that offer the most effective and efficient delivery method.

Information / How to Implement:

Drip irrigation systems provide water directly to root systems where it is most needed, making it more efficient than spray systems. Water runoff and evaporation are minimized with drip irrigation systems. Drip systems are the preferred irrigation method in the desert regions of the United States, but are also recommended in any region where lawns and bedding areas require supplemental watering during the growing season.

Resources:

- *Turf and Landscape Irrigation Best Management Practices*, Irrigation Association, www.irrigation.org/PDF/IA_BMP_FEB_2004.pdf
- *Landscaping Irrigation Systems*, H2ouse.org., the California Urban Water Conservation Council, www.h2ouse.org/tour/details/element_action_contents.cfm?elementID=68BAD0B5-0C95-4AE8-8EC6EC8D76A4CBE1&actionID=BD9DA9D3-0CFA-4F05-B3CBFEC63E2EEE57&roomID=F80B1F87-C00D-498C-9C1F1E5BE9D04637



4.1.8 Irrigation system zoned separately for turf and bedding areas.

Intent:

Control irrigation to individual areas.

Information / How to Implement:

Turf and bedding areas have different irrigation needs based on the various types of grasses and vegetation planted. Zoned irrigation systems allow for distributed control of the flow of water to each individual turf or bedding area. Zoned systems can conserve water by providing irrigation on a selective basis since most plants require 25% to 50% less water than lawns.

Resources:

- *Turf and Landscape Irrigation Best Management Practices*, Irrigation Association, www.irrigation.org/PDF/IA_BMP_FEB_2004.pdf
- *Landscaping Irrigation Systems*, H2ouse.org., the California Urban Water Conservation Council, www.h2ouse.org/tour/details/element_action_contents.cfm?elementID=68BAD0B5-0C95-4AE8-8EC6EC8D76A4CBE1&actionID=BD9DA9D3-0CFA-4F05-B3CBFEC63E2EEE57&roomID=F80B1F87-C00D-498C-9C1F1E5BE9D04637

4.1.9 Weather-based irrigation controls, e.g., moisture-sensor, computer-based weather record.

Intent:

Conserve water by providing irrigation on an “as needed” basis.

Information / How to Implement:

The portion of household water used outdoors varies by climate but can be up to 60% of all household water use. Currently, most irrigation systems are controlled by automatic timers. The systems operate at a particular time each day regardless of whether it has rained recently. Often, assessing the need for watering by visual observation or surface conditions can be difficult since watering needs are based on conditions at the roots. The recommended method for irri-

gation control is to use sensors that activate irrigation based on soil moisture content. This not only saves water but also provides the optimum conditions for the turf grass or plants in question since over-watering can be as detrimental to healthy plant growth as insufficient water.

Computer-based controls use historical local weather data to project anticipated weather patterns and time outdoor watering accordingly.

Resources:

- *Turf and Landscape Irrigation Best Management Practices*, Irrigation Association, www.irrigation.org/PDF/IA_BMP_FEB_2004.pdf
- University of Nebraska drought monitoring site by U.S. state, <http://drought.unl.edu/dm/monitor.html>
- Soil type and classification, Association of American State Geologists, www.kgs.ukans.edu/AASG/AASG.html

4.1.10 Collect and use rainwater as permitted by local code. (Additional credit for distribution systems that use a renewable energy source or gravity.)

Intent:

Reduce water needs for irrigation by collecting and using rainwater.

Information / How to Implement:

Rainwater collection systems store rainwater for future watering and irrigation needs. Collecting rainwater keeps rainwater onsite, thus lowering the impact on storm water collection and conveyance systems and helping to replenish aquifers. See Resources for information about how to construct a rainwater harvesting system and related code issues. Many types of rainwater collection systems are also available commercially.

Resources:

- PATH Technology Inventory, *Rainwater Harvesting*: www.toolbase.org/tertiaryT.asp?TrackID=&CategoryID=1315&DocumentID=2129
- Harvesting Rainwater for Landscape Use: <http://ag.arizona.edu/pubs/water/az1052/harvest.html>
- Garden supply houses

4.1.11 Innovative wastewater technology as permitted by local code, e.g., constructed wetland, sand filter, and aerobic system.

Intent:

Communities often rely on municipal sewage treatment systems rather than onsite wastewater systems because of the generally higher level of supervision and control. However, if onsite processing is the only option for a builder on a lot, the builder will be rewarded for using advanced measures that more effectively process waste and reduce constituents such as nitrogen, which, if in plentiful supply, can be harmful to water bodies.

Information / How to Implement:

Innovative wastewater systems are a technological advancement over conventional septic systems. These technologies treat wastewater to higher levels, resulting in cleaner effluent discharge, improved system operation, and lower impact on the environment.

Resources:

- United States Environmental Protection Agency, Office of Water, Office of Research and Development, *Onsite Wastewater Treatment Systems Manual*, EPA/625/R-00/008, February 2002, www.epa.gov/ORD/NRMRL/Pubs/625R00008/html/625R00008.htm
- University of Minnesota Extension Service: www.extension.umn.edu/distribution/naturalresources/DD7734.html
- Alternative Individual Wastewater Systems fact sheet: www.toolbase.org/tertiaryT.asp?TrackID=&CategoryID=1325&DocumentID=2258
- Onsite Sewage Disposal Systems fact sheet: www.toolbase.org/tertiaryT.asp?TrackID=&CategoryID=1291&DocumentID=4063

4.2 INNOVATIVE OPTIONS

4.2.1 Shut-off valve or pedal-activated faucet to enable intermittent on/off operation.

Intent:

Reduce water waste by installing a faucet control that allows the user, via a (typically) hands-free method, to turn water on and off without changing the temperature.

Information / How to Implement:

Motion-sensor devices automatically control on/off operation of the faucet. Pedal-activated faucets allow individuals to use their feet to control the faucet. Both systems conserve water by reducing the duration of a water flow event.

Resources:

- U.S. DOE, Greening Federal Facilities, Showers, Faucets and Drinking Fountains www.eere.energy.gov/femp/pdfs/29267-6.3.pdf



4.2.2 Separate and reuse greywater as permitted by local code.

Intent:

Reduce total household water consumption by reusing greywater, i.e., water generated from the laundry, showers, and sinks.

Information / How to Implement:

Greywater reuse is the process of recycling laundry, shower, and sink water for non-potable uses. Greywater is typically used to irrigate lawns, trees, shrubs, and vegetation and can also be used to flush toilets. Reusing greywater can significantly reduce total household water consumption.

Resources:

- PATH Technology Inventory: www.toolbase.org/tertiaryT.asp?TrackID=&DocumentID=2137&CategoryID=1002
- Greywater: www.greywater.com
- Arizona Department of Environmental Quality, Using Gray Water at Home: www.deq.co.pima.az.us/water/Water%20PDFs/graywater.pdf

4.2.3 Composting or waterless toilet installed as permitted by local code.

Intent:

Eliminate water use associated with toilet flushing by installing composting or waterless toilets.

Information / How to Implement:

Composting or waterless toilets do not use water.

Resources

- EPA, Technology Fact Sheet, Composting Toilets: www.epa.gov/owm/mtb/comp.pdf
- Sustainable Building Sourcebook, Composting Toilets: www.greenbuilder.com/sourcebook/CompostToilet.html
- What is a composting toilet? www.oikos.com/library/compostingtoilet/
- Composting Toilets: www.compostingtoilet.org/

GENERAL RESOURCES

- The Sustainable Building Sourcebook, www.greenbuilder.com
- The Healthy House Institute, www.hhinst.com
- For Volatile Organic Compounds, www.concretenetwork.com/concrete/finished_basements/a_word_about_vocs.htm
- For Building Material Emissions Study, www.ciwmb.ca.gov/Publications/GreenBuilding/43303015.doc
- For spot ventilation, see the fact sheet *Spot Ventilation—source control to improve indoor air quality* www.toolbase.org/Docs/MainNav/Energy/3947_spotventilation1.pdf?TrackID=&CategoryID=1004&DocumentID=3947 (Sept 2004)
- EPA. *A Guide to Indoor Air Quality*; www.epa.gov/iaq/pubs/insidest.html (Sept 2004)
- *Mold in Residential Buildings*, www.toolbase.org/tertiaryT.asp?TrackID=&CategoryID=1554&DocumentID=2944 (Sept 2004)

5.1 MINIMIZE POTENTIAL SOURCES OF POLLUTANTS.

5.1.1 For vented space heating and water heating equipment:

A. Install direct vent equipment.

Or

B. Install induced/mechanical draft combustion equipment.

Intent:

There are concerns that exhaust vents (bathroom, kitchen, etc.) can depressurize a tight home and cause the byproducts of combustion from appliances to be drawn into the home. If installing combustion space and water heating appliances, minimize the back-drafting potential by choosing direct-vent (sealed combustion) or mechanical/induced-draft (power-vented) equipment. All space and water heating appliances must meet these criteria to receive points.

Note: Points can be obtained for this guideline by mixing equipment types. For instance, direct-vent space heating equipment and an induced-draft water heater can be installed and receive credit.

Information / How to Implement:

Combustion appliance manufacturers offer equipment with various means of exhausting by-products:

- 1) Unvented equipment (aka, ventless, vent-free) where byproducts are exhausted into the home;
- 2) Natural draft equipment (aka, atmospherically vented) where environmental pressure and temperature differences cause by-products to be drawn up a chimney which is directly connected to the equipment;
- 3) Mechanical draft equipment (aka, induced draft, power vented) where by-products are exhausted through a vent due to pressure differences created by a fan, blower, or ejector located in the vent, or

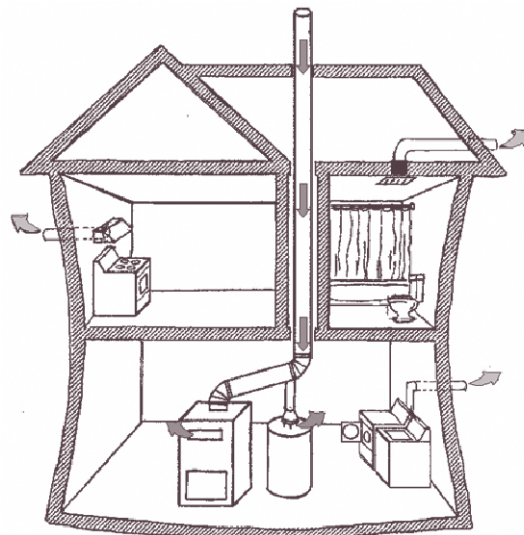

- 4) Direct-vent equipment where all combustion takes place in a sealed chamber. Combustion air is drawn directly from the outdoors into the chamber. Products of combustion are then vented directly outdoors. Direct-vent space heating equipment also has an energy benefit as compared with natural draft or mechanical draft equipment. The Annual Fuel Utilization Efficiency (AFUE) of direct-vent equipment is typically above 85%.

Direct-vent water heaters remain quite expensive. Mechanically vented or electric water heaters may be the most practical option for many builders wishing to comply with this guideline. Some local codes may require an outdoor source of combustion air for mechanical draft equipment.

An alternative to direct vent equipment includes isolating combustion equipment from the conditioned space, such as constructing a combustion closet (see 5.1.2).

Resources:

- Koontz, M.D., N.L. Nagda. *Depressurization-Induced Backdrafting and Spillage: Implications of Results from North American Field Studies*. ASHRAE Winter Meeting; January 12–16, 2002, Atlantic City, New Jersey. AC-02-3-2. Atlanta, GA: American Society of Heating, Refrigeration and Air-Conditioning Engineers, Inc., 2002
- National Fire Protection Association, *American Gas Association. National Fuel Gas Code*. 2002 Edition. NFPA 54-2002. ANSI Z2223.1-2002. Section G2406 (303) Appliance Location
- American Society of Heating, Refrigeration and Air-Conditioning Engineers, Inc. *ASHRAE Standard 62-1989*
- Lstiburek, J., *Builder's Guide: Hot-Dry & Mixed-Dry Climates*. Westford, MA: Building Science Corporation, September 2000
- Lstiburek, J., *Builder's Guide: Hot-Humid Climates*. Westford, MA: Building Science Corporation, January 2002
- Lstiburek, J., *Builder's Guide: Hot-Humid Climates*. Westford, MA: Building Science Corporation, February 2002
- www.epa.gov/iaq/homes/ Search for “Preventing Problems with Combustion Equipment” and “What You Should Know About Combustion Appliances and Indoor Air Pollution”

5.1.2 Install space heating and water heating equipment in an isolated mechanical room or closet with an outdoor source of combustion and ventilation air.

Intent:

Installing combustion appliances in an isolated space, such as in a combustion closet, can minimize the concern that combustion byproducts could be drawn into the home.

Information / How to Implement:

A combustion closet is an area sealed off from the conditioned space. Insulate and seal all walls and the ceiling, install a solid door with weather stripping and a sufficient threshold, and extend ducts outside the building envelope to provide combustion and ventilation air.

Alternatives include installing direct-vent or mechanical/induced-draft equipment (see 5.1.a-b) or installing electric equipment.

Resources:

- Efficiency and Renewable Energy, U.S. Department of Energy. *Combustion Equipment Safety: Provide Safe Installation for Combustion Appliances*. Page 3, Combustion Closet Design chapter

5.1.3 Install direct-vent sealed combustion gas fireplace, sealed wood fireplace, or sealed woodstove.

Or

No fireplace or woodstove installed.

Intent:

Direct-vent sealed combustion gas fireplaces, or sealed wood burning fireplaces, and sealed woodstoves minimize the risk of smoke and combustion byproducts back-drafting into the home. Outdoor air is also supplied directly to the combustion chamber so that indoor air is not required for combustion.

Information / How to Implement:

Fireplaces typically come in:

- Wood burning (uses room air for combustion, and exhausts up a chimney)
- Vented gas (uses room air for combustion, exhausts through vent or chimney),
- Directvent gas (aka, “sealed combustion,” outdoor combustion air provided directly to sealed combustion chamber, exhausts through vent or chimney), or
- Vent-free gas (uses room air for combustion and exhausts to room).

When installing a wood-burning stove or fireplace, make sure it is sealed with a gasketed door. Recognize that a wood-burning fireplace is only about 10 to 30% efficient. Consider specifying an EPA-certified wood stove, which has efficiencies of around 69 to 78 percent. EPA-certified woodstoves and gas appliances minimize outdoor air pollution.

Direct-vent fireplaces (aka, sealed combustion) are more energy efficient than wood fireplaces and atmospherically-vented gas fireplaces. They use outside air for combustion and exhaust directly to the outside. Like vented gas fireplaces, they typically use a heat exchanger to circulate warm air through the room but keep combustion air separate from room air.

Resources:

- U.S. Department of Energy, Office of Energy Efficiency and Renewable Energy. Consumer Energy Information: EREC Reference Briefs. *Air Pollution from Wood-Burning Appliances and Fireplaces* www.eere.energy.gov/consumerinfo/factsheets/ja3.html.
- Hearth, Patio, and Barbecue Association (HPBA). <http://hpba.org>
- HPBA fact sheet on EPA-certified wood burning www.hpba.org/communications/FactSheets/Fact03-EPAWoodBurn3.pdf
- HPBA fact sheet *Wood Burning Fireplaces* www.hpba.org/communications/FactSheets/WoodBurningFireplace.pdf
- HPBA fact sheet, Gas Fireplaces www.hpba.org/communications/FactSheets/GasFireplace.pdf
- National Fireplace Institute. nficertified.org. Find a certified installer. NFI Certification identifies those individuals who have passed an exam based on the knowledge needed to properly plan and install hearth products and their venting systems.
- U.S. EPA Compliance Monitoring, *Woodstoves*: www.epa.gov/compliance/monitoring/programs/woodstoves
- For fireplace venting options, www.fireplacenow.com/_content_/VentingOptions.htm (Sept 2004)

5.1.4 Ensure a tightly-sealed door between the garage and living area and provide continuous air barrier between garage and living areas including air-sealing penetrations, walls, ceilings, and floors.

Intent:

Walls and ceilings between a garage and the living space should be tightly sealed to prevent car exhaust and other fumes from entering the living space. Pressure differences can cause fumes to be drawn into the living space through common walls and ceilings. Providing a continuous, sealed air barrier along this wall and sealing all penetrations will greatly reduce the potential for contaminants to enter the home from the garage.

Automated mechanical ventilation is sometimes used to exhaust air from the garage to the outdoors. Because this type of system creates negative pressure in the garage, pollutants are less likely to be drawn into the home. However, mechanical ventilation is not a substitute for air sealing because wind speed and direction affect its performance. An alternative to providing a continuous air barrier is to construct a detached garage. However, this option requires more construction materials and therefore has a somewhat negative impact on resource efficiency.

Information / How to Implement:

A continuous air barrier, which decouples garage air from living space air, can be accomplished in many ways. Before the framed wall is enclosed, seal or caulk all penetrations, gasket or seal sills, caulk inside edges of top and bottom plate, install cavity insulation, and install an air barrier such as rigid foam or a sheet barrier (not a vapor retarder) overlapped and taped at joints and corners and attached to the bottom plate, drywall walls and ceiling, tape and spackle all seams. Gasketed drywall or the airtight drywall approach may also be used.

At a minimum, caulk the drywall to the bottom plate, tape and spackle all drywall seams, and seal all penetrations. Only sealing the plates is not enough; air can enter between the drywall and the bottom plate, move through the stud bays, and out of the corresponding gap on the inside wall.

Resources:

- Super Good Cents Builders Field Guide—Chapter 9, Air Tightening Specialist
- Building Science Corporation: Figure 19. www.buildingscience.com/housethatwork/hotdry/tucson.htm
- http://oikos.com/library/airsealing/rim_joists.html
- Wilber, M.W. and S.R. Klossner. 1997. A Study of Undiagnosed Carbon Monoxide Complaints. Healthy Buildings/IAQ '97: Global Issues and Regional Solutions, Vol. 3, Bethesda, Maryland, Sept 27-Oct, 1997
- Bohac, D.L. and T. H. Brown. 1997. Results from IAQ Evaluations on Cold Climate Single Family Houses Undergoing Sound Insulation. Healthy Buildings/IAQ '97: Global Issues and Regional Solutions, Vol. 3, Bethesda, Maryland, Sept 27-Oct, 1997

5.1.5 Ensure particleboard, medium-density fiberboard (MDF), and hardwood plywood substrates are certified to low formaldehyde emission standards ANSI A208.1, ANSI A208.2, and ANSI/HPVA HP1, respectively. Composite wood/agrifiber panel products must either contain no added urea-formaldehyde resins or must be third-party certified for low formaldehyde emissions.

Intent:

Products certified as having low formaldehyde emissions have less detrimental effect on indoor air quality than uncertified products. In June 2004, the International Agency for Research on Cancer (IARC) declared formaldehyde a known human carcinogen. The glue used to bind materials in wooden board products often contains formaldehyde. Over time, Formaldehyde can leach out of these materials and into the home.

Information / How to Implement:

When purchasing wood panel products, look for materials certified as having low formaldehyde emissions. The Composite Panel Association's Environmentally Preferable Product Certification Program certifies that composite panels at least meet the appropriate ANSI product criteria. Particleboard should be in conformance with ANSI A208.1-1993. For particleboard flooring, look for ANSI grades "PBU," "D2," or "D3" stamped on the panel. MDF should be in conformance with ANSI A208.2-1994 and hardwood plywood with ANSI/HPVA HP-1-1994.

Resources:

- IARC Monographs on the Evaluation of Carcinogenic Risks to Humans—monographs.iarc.fr/htdocs/announcements/vol88.htm
- www.buildinggreen.com—GreenSpec Directory
- The Composite Panel Association (CPA) Environmentally Preferable Product (EPP) Certification Program, www.pbmdf.com/AboutCPA/EPP.asp
- www.eppbuildingproducts.org/specifications/draftspecs/RevisedCP.attachment/30/EPPD_Composite_Panels_052405.pdf
This work is currently underway and may not be completed as of the printing of these guidelines.
- GreenGuard certifies products for low emissions. As of September 2004, only one engineered wood product was listed. www.Greenguard.org
- For formaldehyde-free MDF, check www.advancedbuildings.org/main_t_finishes_formaldehyde.htm, Sept 2004.

5.1.6 Install carpet, carpet pad, and floor covering adhesives that hold the "Green Label" from Carpet and Rug Institute's indoor air quality testing program or meet equivalent thresholds verified by a third party.

Intent:

Reduce VOC emissions from carpets by installing carpets certified by a third-party testing agency as low emitting.



Information / How to Implement:

The Carpet and Rug Institute administers a testing program to identify low-emitting carpets, carpet pads, and floor covering adhesives. Look for the "Green Label" when purchasing carpets. Natural fiber carpets are also good alternative floor coverings.

Resources:

- www.carpet-rug.com/drill_down_2.cfm?page=8&sub=4&requesttimeout=350
- Wargocki, P., D.P. Wyon, Y.K. Balk, G. Clausen and P.O. Fanger. 1999. Perceived Air Quality, Sick Building Syndrome Symptoms and Productivity in an Office with Two Different Pollution Loads. *Indoor Air* 1999, vol. 9: 165-179.
- Environmental Protection Agency. www.epa.gov/iaq/formalde.html (Sept 2004)

5.1.7 Mask HVAC outlets during construction and vacuum ducts, boots, and grilles before turning on central heating/cooling system.

Intent:

When possible, do not operate ducted HVAC equipment during construction. Remove dust and dirt from supply and return ducts before putting the equipment into operation to minimize airborne pollutants.

Information / How to Implement:

Tightly cover openings with materials such as cardboard and tape, especially during tasks that create significant dust such as drywall or floor sanding. It is not necessary to professionally clean ducts to comply with this guideline. Rather, use a shop vacuum to remove dust and debris close to the openings.

Resources:

- Information will be added in Version 2.

5.1.8 Use low-VOC-emitting wallpaper.**Intent:**

Use low-VOC-emitting wallpaper to reduce potentially harmful VOCs from being emitted into the indoor air.

Information / How to Implement:

Use materials certified by a third party as having low VOC emissions.

The reason this line item is in the IEQ guiding principle and the low VOC paints line item is in the “Global Impacts” guiding principle is because once the homeowner moves into a new home, the vast majority of VOCs in paints have already been released to the atmosphere and are thus do not have a significant impact on indoor environmental quality. However, wallpaper releases VOCs more slowly. Thus, there is still a relatively good amount of VOCs remaining in wallpaper after a homeowner moves into a new home.

Resources:

- www.greenguard.org
- *Green from Wall to Wall* by Environmental Design+Construction, www.edcmag.com/CDA/ArticleInformation/coverstory/BNPCoverStoryItem/0,4118,128601,00.html (Sept 2004)
- *Paints and Wall Coverings* by DOE, Energy Efficiency and Renewable Energy. www.eere.energy.gov/femp/pdfs/29267-7.1.6.pdf (Sept 2004)

5.2 MANAGE POTENTIAL POLLUTANTS GENERATED IN THE HOME.**5.2.1 Vent kitchen range exhaust to the outside.****Intent:**

Remove moisture, odors, and combustion byproducts.

Information / How to Implement:

Install a range hood that is vented to the outside. Because a vented hood requires another puncture in the building envelope, be sure to tightly seal around the penetration. Take caution not to over-ventilate. Large kitchen exhaust fans can increase the potential for back-drafting if there are other combustion appliances in the home. (See 5.1.1 above.) The Home Ventilating Institute recommends a range hood with a minimum rate of 40 CFM per lineal foot of range top for wall-mounted hoods and 50 CFM per lineal foot for island hoods. For cooking that generates heavier steam or smoke, HVI recommends 100 CFM per lineal foot for wall-mounted hoods and 150 CFM per lineal foot for island hoods. Duct length and routing can affect flow rates; be sure to verify the flow rate is as designed.

Resources:

- Home Ventilating Institute, www.hvi.org
- American Society of Heating, Refrigeration and Air-Conditioning Engineers, ASHRAE Standard 62-1989
- 2003 IRC, Page 302, Section M1506.3 Ventilation Rate

- State of California. Reducing Indoor Air Pollution, www.arb.ca.gov/research/indoor/rediap.htm (Sept 2004)
- Doiron, Jacques, Cleaner cooking. www.canadianhomeworkshop.com/quickfix/kitchen_vent.shtml (Sept 2004)
- Miltner, Karen, Keeping Kitchen Smells Fresh. www.democratandchronicle.com/homes/buyersguide/1010G221OKH_HOODS11_Homes.shtml (Sept 2004)

5.2.2 Provide mechanical ventilation at a rate of 7.5 cfm per bedroom +7.5 cfm and controlled automatically or continuous with manual override. The ventilation equipment may be:

- A. Exhaust or supply fan(s)
- B. Balanced exhaust and supply fans
- C. Heat recovery ventilator
- D. Energy recovery ventilator.

Intent:

Provide small amount of background ventilation to ensure that indoor air is exchanged at a consistent and adequate rate.

Information / How to Implement:

It is advantageous from an indoor environmental quality perspective and for energy-efficiency purposes and comfort to construct a tight building envelope. Air infiltration not only contributes to energy loss but can also cause mold problems if warmer air condenses when it reaches a cooler surface as it moves through a wall cavity. However, a very tight building shell can create the need for an intentional means of introducing fresh air into the living space. Introducing outdoor air into the home in a controlled manner has both an energy and IEQ advantage.

Exhaust or Supply Fan: Kitchen or bath exhaust fans can be part of a whole-house ventilation strategy in cold climates if fans are controlled with timers or humidistats. As air is exhausted from the home, the negative pressure created pulls in outdoor air from nooks and crannies in the building envelope. The practice is not recommended in warm, humid climates because humid, outdoor air traveling through a wall cavity can create moisture problems. In these climates, supply-only ventilation is preferable. For supply-only ventilation, locate the ducts carefully since cold or hot outdoor air can create comfort issues.

Balanced Exhaust and Supply Fan: Balanced ventilation does not contribute to pressure imbalances between indoors and out. As air is exhausted by one (or more) fans, fresh air is introduced by another. One option for balanced ventilation is to use bath fans for the exhaust and to install a small duct from outside to the return side of the air handler on a central heating or cooling system. Controls and timers are then used to operate the fans and air handler simultaneously or as desired. Outdoor air can also be supplied directly to the home with a separate fan, but take care in locating the ducts so that comfort is not compromised.

Heat or Energy Recovery Ventilators: These systems are also a form of balanced ventilation. In addition to supplying fresh air and exhausting stale air, they precondition the incoming air to some degree. Heat recovery ventilators exchange sensible heat while energy recovery ventilators transfer moisture to some extent as well. Thus, in a humid climate, some moisture from the incoming air is transferred to the exhaust stream. Energy recovery ventilators are not dehumidifiers; they transfer moisture from one air stream to another. For severely humid climates, one should consider a dehumidifying ventilator. Typically, heat recovery ventilators are recommended for cold climates and energy recovery ventilators for hot climates. However, if dry indoor air is a potential issue in a heating-dominated climate, an energy-recovery ventilator may be preferred.

See also Section 3.3.1B under the Energy Efficiency section.

Resources:

American Society of Heating, Refrigeration and Air-Conditioning Engineers, Inc. ASHRAE Standard 62-1989

5.2.3 Install MERV 9 filters on central air or ventilation systems.

Intent:

Reduce the amount of airborne particulates.

Information / How to Implement:

MERV 9 filters remove particles larger than 3 microns and are more effective than standard spun fiber filters. MERV 9 filters capture dust but not contaminants such as molds and bacteria that are in the 1-micron range. Some studies have shown that 97% of airborne particles are 1 micron or less. Filters with a greater efficiency are often not recommended for space heating and cooling equipment because they may restrict airflow too much. More efficient filters such as MERV 9 also have a resource efficiency benefit from the standpoint that more dust is captured by the filter and is not deposited on the air handler.

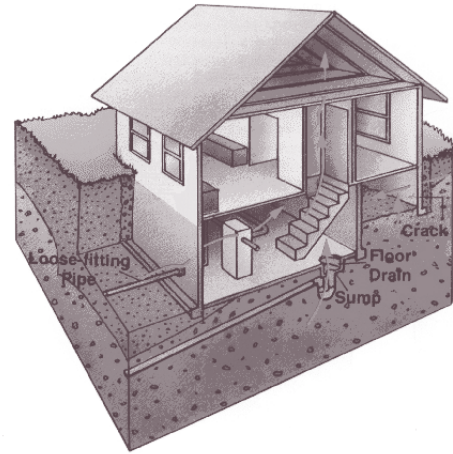

Radon can enter a house through many paths.

Resources:

- National Institute for Occupational Safety and Health. Guidance for Protecting Building Environments from Airborne Chemical, Biological, or Radiological Attacks. www.cdc.gov/niosh/docs/2003-136/2003-136c.html (Sept. 2004)
- CHMC “What a Furnace Filter Can Do For You” www.cmhc-schl.gc.ca/en/burema/gesein/abhose/abhose_ce22.cfm (Sept. 2004)

5.2.4 Install humidistat to control whole-house humidification system.

Intent:

Control excessive humidification, which can result in moisture damage.

Information / How to Implement:

Indoor humidity should be between 30 and 60 percent. Indoor humidity below 30 percent causes dry eyes, nose, and throat, which are not only uncomfortable but also an invitation for bacteria and viruses. At the other extreme, indoor humidity above about 60% can contribute to the potential for mold growth. Given temperatures between 40 and 80 degrees Fahrenheit and a food source (wood, paint, dirt, dust), mold will grow within 24 to 48 hours. Therefore, if a whole-house humidification system is installed, it should have an adjustable humidistat control to avoid excessive humidification.

Resources:

- ToolBase Website. Humidity-Sensing Control Device www.toolbase.org/tertiaryT.asp?TrackID=&DocumentID=2096&CategoryID=960 (Sept. 2004)

5.2.5 Install sub-slab depressurization system or infrastructure to facilitate future installation of radon mitigation system. When applicable, the more stringent requirement of local building code and this provision shall apply.

Intent:

Prevent radon gas from entering the home.

Information / How to Implement:

Radon is a naturally occurring gas spontaneously produced from the decay of radium. Radon levels can vary in outdoor air, indoor air, soil, and ground water. Radon is a carcinogen that can enter through voids in a home's foundation and become trapped inside. Radon gas can easily be directed outside with a few basic construction designs.

Text and graphic from www.epa.gov/radon/construc.html

A. Gas-Permeable Layer

This layer is placed beneath the slab or flooring system to allow the soil gas to move freely underneath the house. In many cases, the material used is a four-inch layer of clean gravel.

B. Plastic Sheetting

Plastic sheetting is placed on top of the gas-permeable layer and under the slab to help prevent the soil gas from entering the home. In crawl spaces, the sheetting is placed over the crawl space floor.

C. Sealing and Caulking

All openings in the concrete foundation floor are sealed to reduce soil gas entry into the home.

D. Vent Pipe

A three- or four-inch gas-tight or PVC pipe (commonly used for plumbing) runs from the gas-permeable layer through the house to the roof to safely vent radon and other soil gases above the house.

E. Junction Box

An electrical junction box is installed in case an electric venting fan is needed later.

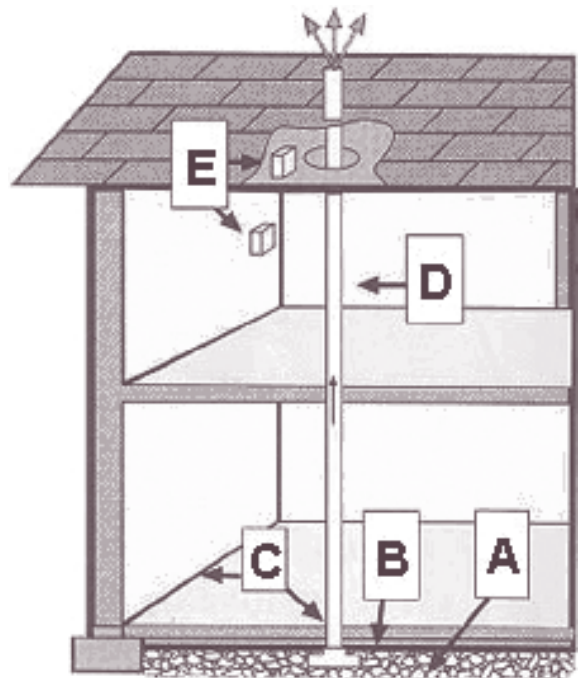

Note that in high radon areas, special consideration should be taken to treat well water. Simple water treatments are available. For more information, call EPA's Drinking Water Hotline at (800) 426-4791, visit www.epa.gov/safewater/radon.html, or contact the state radon office.

Resources:

- 2003 IRC, Page 559
- HBA: Use radioactivity maps from USGS, state geological surveys, colleges/universities to better know the dangerous radon zones in your area. <http://energy.cr.usgs.gov/radon/georadon/4.html>
- Radon map for Prince George's and Montgomery counties from USGS <http://energy.cr.usgs.gov/radon/georadon/4.html>



- EPA's map of radon zones by county www.epa.gov/radon/zonemap.html
- HBA: EPA also recommends contacting your state radon representative. EPA has a list of contacts on its website at www.epa.gov/iaq/wherelive.html
- www.epa.gov/radon
- *Radon Resistant New Construction*—www.epa.gov/radon/construc.html
- 2000 IRC, Page 564, *Radon-resistant construction details for four foundation types*
- For Radon remediation, check www.toolbase.org/secondaryT.asp?TrackID=&CategoryID=1174

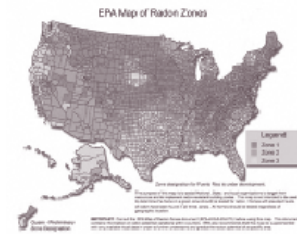

5.2.6 Verify all exhaust flows meet design specifications.

Intent:

Ensure all exhaust flows are operating as designed.

Information / How to Implement:

If ductwork is not properly sized and installed, fan flow may be restricted and not exhaust air at its rated capacity. For example, a fan rated at 50 CFM may exhaust only 35 CFM if duct runs are extremely long or if ductwork is kinked during installation. Without adequate fan capacity, moisture may not be properly removed. Size ducts according to the manufacturer's recommendation for diameter and maximum length. Fans should perform within 10% of their rated capacity. After installation, visually inspect the duct length, look for crimped or damaged ducts, check for missing parts, and ensure that connections are secure. A more accurate method of checking fan airflow is to use a flow hood or pitot tube and manometer. Ask the installer about methods of checking airflow.

Resources:

- ACCA Manual D www.cmhc-schl.gc.ca/en/burema/gesein/abhose/abhose_ce17.cfm
- Flow hood equipment—www.energyconservatory.com/products/products1.htm

5.3 MOISTURE MANAGEMENT (VAPOR, RAINWATER, PLUMBING, HVAC)

Intent:

Reduce risk of moisture accumulation, which can lead to deterioration of building products and potential mold problems.

Information / How to Implement:

See Resources section.

Resources:

- Lstiburek J., and J. Carmody, *Moisture Control Handbook, Principles and Practices for Residential and Small Commercial Buildings*, Wiley, 1996

5.3.1 Control bathroom exhaust fan with a timer or humidistat.

Intent:

Ensure that fans are operated in a manner that removes moisture without relying on input from the homeowner, and remove residual moisture from bathrooms after use.

Information / How to Implement:

Often, bath fans are used infrequently because of their noise, a lack of understanding of their importance by the homeowner, or simply because the homeowner is not in the habit of doing so. Installing controllers on fans, especially timers or humidistats that remove residual humidity after a person leaves the bathroom, is an effective method for removing interior generated moisture at its source. Timers can also prevent unnecessary fan energy use that occurs when a fan is inadvertently left on.

Timers and humidistats are basically upgraded switches. They are wired in and mounted like a typical switch. Timers can typically be set to run from 10 to 60 minutes. Homeowners should be instructed to run bathroom exhaust fans for 20 minutes after a bath or shower. Humidistats will automatically cycle the fan on and off to maintain proper humidity levels; they can be adjusted to operate between 20% and 80% relative humidity. Timers and humidistats cost about \$25 and up. Bath fans are also available with integral humidistats and timers.

See Section 3.3.2 for information about energy-efficient exhaust fans.

Resources:

- <http://energyoutlet.com/res/fan/>
- www.cmhc-schl.gc.ca/en/burema/gesein/abhose/abhose_ce17.cfm
- *Moisture Control in Bathrooms* by Home Energy Magazine Online. <http://hem.dis.anl.gov/eehem/98/980310.html> (Sept 2004)
- *Spot ventilation—source control to improve indoor air quality*. www.toolbase.org/docs/MainNav/Energy/3947_spotventilation1.pdf (Sept 2004)

5.3.2 Install moisture resistant backerboard, not paper-faced sheathing, under tiled surfaces in wet areas.**Intent:**

Reduce the risk of problems if water penetrates tile surfaces in kitchens and baths.

Information / How to Implement:

A cement-based backerboard does not contain organic paper that can deteriorate, swell (potentially causing cracking in the grout), and be a substrate for mold growth when wet. Cement backerboard is resistant to the deleterious effects of moisture.

Resources:

Backerboard manufacturer Web sites for installation information (e.g., WonderBoard, Durock)
Tile Council of America, 2003-2004 Handbook for the Installation of Ceramic Tile, www.tileusa.com

5.3.3 Install vapor retarder directly under slab (6 mil) or on crawl-space floor (8 mil). In crawl spaces, extend poly up wall and affix with glue and furring strips, or damp-proof wall below grade. Joints should be lapped 12 inches.**Intent:**

Prevent moisture migration from the ground through wicking action (through slab) or by vapor movement (in crawl space).

Information / How to Implement:

A vapor retarder should be continuous with joints lapped 12 inches and taped, if possible. Any penetrations or other areas where the vapor retarder has been compromised should be sealed with tape or caulk.

Resources:

- Carter, Tim. *Vapor Retarders Will Stop Odors and Moisture*. www.askthebuilder.com/printer_279_Vapor_Retarders_Will_Stop_Odors_and_Moisture.shtml (Sept 2004)
- Makela, Eric, et al. *How to construct unventilated crawlspace to meet the provisions*. USDOE. www.holtonhomes.com/webcast_04_crawlspaces.pdf (Sept 2004)
- *Crawlspace Moisture Control*, fact sheet by Dominion Power, www.dom.com/customer/efficiency/res/answers/pdf/crawlspaces.pdf%20
- *EEBA Builders' Guides (for Cold, Mixed-Humid, Hot-Dry/Mixed-Dry, and Hot-Humid Climates)*, available from the Energy and Environmental Building Association's Web site at www.eeba.org/mall/builder_guides.asp

5.3.4 Protect unused moisture-sensitive materials from water damage through just-in-time delivery, storing unused materials in a dry area, or tenting materials and storing them on a raised platform.**Intent:**

Prevent wetting of building materials through proper storage techniques during construction. Wetting of building materials can lead to dimensional instability, deterioration, and mold growth.

Information / How to Implement:

Lumber should be inspected upon delivery for moisture and mold. Delivery should be scheduled so that lumber is used soon after it is received at the site. Lumber should not be stored in direct contact with the ground: It should be elevated to allow air circulation and to prevent absorption of ground moisture. Lumber that is stored outside should be covered in an open area in a way that will protect the wood from rain and snow but will also allow water vapor to escape, such as by covering it with house-wrap (plastic sheeting can trap moisture). Interior architectural items such as flooring, trim, and cabinets should be stored indoors until they reach equilibrium with interior moisture levels. This guideline is also a cost-effective measure—by protecting materials from the weather, waste from warping, shrinking, and swelling can be avoided.

Resources:

- *Panel Selection, Handling, Storage*. OSB Design and Construction Guide. March 2000. PFS Research Foundation. Madison, WI
- Forest Products Laboratory. 1999. *Wood handbook—Wood as an engineering material*. Gen. Tech. Rep. FPL-GTR-113. Madison, WI. U.S. Department of Agriculture, Forest Service, Forest Products Laboratory. 463 p. see Section 12, Page 18. Design Factors Affecting Dimensional Change.
- ToolBase. www.toolbase.org/docs/ToolBaseTop/Research/3464_HelpingHomebuyersUnderstandMold.pdf (Sept 2004)
- *Proper Lumber Storage*, Southern Pine Council, www.southernpine.com/lumberstorage.shtml
- *Proper Storage and Handling of Glulam Beams*, APA—The Engineered Wood Association, www.apawood.org/pdfs/managed/R540.pdf
- *Storage and Handling of APA Trademarked Panels*, APA—The Engineered Wood Association, www.apawood.org/pdfs/managed/U450.pdf
- *Storage, Handling, and Safety Recommendations for APA Performance Rated I-Joists*, www.apawood.org/pdfs/managed/Z735.pdf
- (Just-in-Time Delivery) *Industrializing the Residential Construction Site*, 2000. Center for Housing Research, VPI. Available from the U.S. Department of Housing and Urban Development

5.3.5 Keep plumbing supply lines out of the exterior walls.

Intent:

Reduce the potential for condensation by keeping supply pipes in conditioned space, where pipes are not exposed to large temperature and humidity differentials. Also reduce the consequences of a potential plumbing leak, which could lead to wetting of structural members, insulation, and interior finishes.

Information / How to Implement:

Try to cluster bathrooms and other hot water uses, e.g., “stacked” bathrooms, to minimize the need for running supply lines on exterior walls. Water supply lines can be run through duct chases (designed for keeping ducts in conditioned space). When piping must be located in exterior walls, insulation should be placed between the exterior sheathing and the pipe but not between the pipe and the interior wall (to prevent freezing).

Resources:

- *Builder’s Guide to Placement of Ducts and HVAC Equipment in Conditioned Space*, 2000, NAHB Research Center. Available at www.toolbase.org/tertiaryT.asp?TrackID=&DocumentID=2570&CategoryID=110
- Lewis, Bill. *Preventing Frozen Water Pipes*. http://homerepair.about.com/cs/plumbing/a/frozen_pipes_b3.htm (Sept 2004)

5.3.6 Insulate cold water pipes in unconditioned spaces with insulation or other coating that comparably prevents condensation.

Intent:

Reduce the potential for condensation on cold water supply pipes located in unconditioned space by insulating the pipes. This guideline has more relevance in hot, humid climates where piping is more likely to be located in an unconditioned area. Cold water piping installed in crawl spaces can pose a condensation problem in colder regions during the summer months.

Information / How to Implement:

Foam insulation for insulating pipes is readily available and easy to install.

Resources:

- *Preventing and Thawing Frozen Pipes*. www.prepare.org/basic/frozen.htm (Sept 2004)
- Do It Yourself. www.diy.net.com/diy/diy_kits/article/0,2019,DIY_13787_2275412,00.html (Sept 2004)

5.3.7 Insulate HVAC ducts, plenums, and trunks in unconditioned basements and crawl spaces to avoid condensation.

Intent:

Prevent condensation on the outside of cold HVAC ducts located in unconditioned basements and crawl spaces that can lead to moisture problems in those areas.

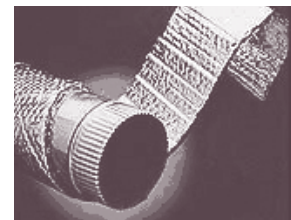
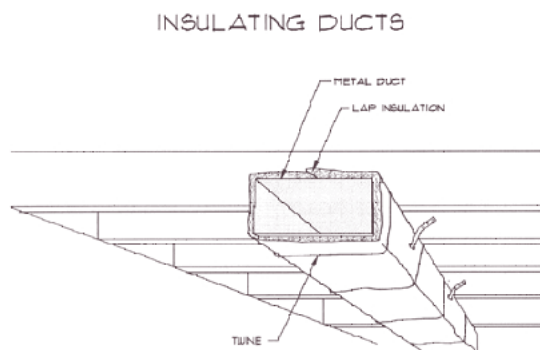

Information / How to Implement:

www.mme.state.va.us/de/energybook/hbchap5.html

After sealing ductwork, use spray foam or wrap a flexible insulation product (e.g., reflective insulation, fiberglass batts) around metal supply ducts, plenums, and trunks in basements and crawl spaces. Do not use flexible ductwork in crawl spaces, as it can be an entry point into the home for vermin.

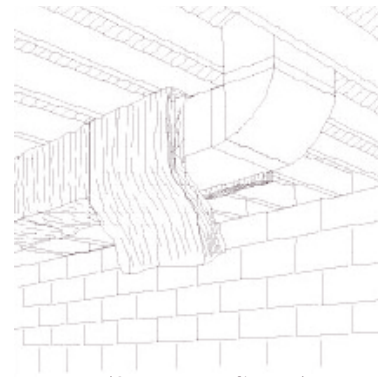

(Source: Reflectix)

Resources:

- Energy Outlet information on duct sealing, available at www.energyoutlet.com/res/ducts/insulating.html
- *Crawlspace Condensation* by Home Energy Magazine Online <http://hem.dis.anl.gov/eehem/01/010304.html> (Sept 2004)
- *Insulating Ducts for Efficiency*. www.bobvila.com/ArticleLibrary/Subject/HVAC/Insulation/InsulatingDucts.html (Sept 2004)

5.3.8 Check moisture content of wood before enclosing on both sides. Ensure moisture content of subfloor/substrate meets the appropriate industry standard for the finish flooring material to be installed.**Intent:**

Because wood's ability to dry is compromised when it is not subject to free airflow, moisture content should be acceptable before the wood is enclosed in a wall or floor joist cavity. Reduce the risk of shrinkage and mold on lumber by ensuring the moisture content of dimensional lumber is below 19% before enclosure.

Information / How to Implement:

Use a moisture meter (preferably a probe-type meter, which is more accurate than the scanning type) to measure the moisture content in the wood and wood subfloor. A sample of wood materials can be checked relatively quickly before installing finish materials.

For hardwood flooring over a truss or joist system, the average moisture content of framing members and subflooring should be below 12% to 14% before delivery of the flooring.

When installing flooring over a concrete slab, testing a concrete slab requires use of a calcium chloride test; the test should show a moisture content of three pounds or less (if no moisture retarder is installed) and four to seven pounds (if a moisture retarder is installed). Per the National Wood Flooring Association's guidelines, wood flooring should not be installed over concrete with readings exceeding seven pounds calcium chloride. Use a surface moisture meter, and perform a calcium chloride test to measure moisture in a concrete slab/subfloor.

Resources:

- National Wood Flooring Association, *Hardwood Flooring Installation Guidelines*, www.nwfa.org.
- The Wood Flooring Manufacturer's Association, *Installing Hardwood Flooring*, www.nofma.org/installation1.htm
- Electric Moisture Meters, ToolBase Services fact sheet, available at www.toolbase.org/tertiaryT.asp?TrackID=&DocumentID=2120&CategoryID=1013 Golden, J.A., 1998, *Moisture Testing Guide for Wood Frame Construction Clad with Exterior Insulation and Finish Systems*, p. 7-8. Available at www.toolbase.org/docs/MainNav/MoistureandLeaks/876_protocol5A.pdf
- *Computing Moisture Content of Wood*. www.woodbin.com/ref/wood/emc.htm (Sept 2004)
- *EPA Moisture Content Calculation*. www.epa.gov/athens/learn2model/part-two/onsite/mc.htm (Sept 2004)

5.4 INNOVATIVE OPTIONS

Information will be added in Version 2.

Ensure that homeowners are aware of the green features of their new home, know how to operate and maintain the home to achieve the highest level of environmental performance, and have a resource for warranty issues.

6.1 PROVIDE MANUAL TO OWNERS/OCCUPANTS ON THE USE AND CARE OF THE HOME THAT INCLUDES ALL OF THE ITEMS BELOW

- A. Narrative detailing the importance of maintenance and operation to keep a green-built home green.
- B. Local Green Building Program's certificate.
- C. Warranty, operation, and maintenance instructions for equipment and appliances.
- D. Household recycling opportunities.
- E. Information on how to enroll in a program for purchasing energy from a renewable energy provider.
- F. Explanation of the benefits of using compact fluorescent light bulbs in high usage areas.
- G. List of habits/actions to optimize water and energy use.
- H. Local transportation options.
- I. Clear labeling of safety valves and controls for major house systems.

Intent:

Help homeowners to “live green” in their green-built home.

Information / How to Implement:

Gather information for homeowners from local and national resources (see Resources). Include information about the green features of the home as well as tips for living in the home with less impact on the environment. Ask whether the local Green Building Program offers a sample Green Homeowner's Manual.

Resources:

- Fannie Mae, *Home Performance Power: Fannie Mae's Guide to Buying and Maintaining a Green Home*. For a copy, call Fannie Mae's Consumer Resource Center at 1-800-7FANNIE (1-800-732-6643).
- NAHB's *Your New Home and How To Take Care of It*
- *The National Home Maintenance Manual*, by California Building Standards
- Your local HBA's Green Building Program office. List of local Green Building Programs at www.toolbase.org (click on “Green Building”).
- Various manufacturers
- City, county, or township recycling information
- U.S. DOE's Green Power Network: www.eere.energy.gov/greenpower/
- Lighting energy savings calculator at www.goodmart.com/light_bulb_energy_saving_calculator.aspx
- Water-saving tips at www.h2ouse.org. Energy-Saving tips: www.eere.energy.gov/consumerinfo/energy_savers/ and www.aceee.org/consumerguide/chklst.htm
- Metropolitan-area, city, county, township, or private public transit information (usually listed in the front of the phone book)
- *Homeowner's Manual—At last, an owner's manual for your new home*. By CMHC. www.cmhc-schl.gc.ca/en/bureho/buho/buho_002.cfm (Sept 2004)
- National Environmental Services Center, www.nesc.wvu.edu/nsfc/NewReleases/nsfc_NR_11_14_03.htm (Sept 2004)

- Community Associations Institute, www.caionline.org/about/homeowner_education.cfm (Sept 2004)
- Massachusetts Housing Partnership, www.mhp.net/homeownership/education.php (Sept 2004)
- How-To Publications by Family Resource Management, College of Agriculture & Home Economics. www.cahe.nmsu.edu/pubs/_g/ (Sept 2004)
- Papolos, Janice. *The Virgin Homeowner: The Essential Guide to Owning, Maintaining, and Surviving Your Home*, Penguin Books. ISBN: 0140274766
- For earthquake safety: www.seismic.ca.gov/pub/CSSC_2002-04_HOG.pdf (Sept 2004)
- For fire prevention: www.ofm.gov.on.ca/english/FirePrevention/FireSmart%20Communities/pdf/User%20guide.pdf (Sept 2004)
- For soil-lead hazard: www.epa.gov/region01/leadsafe/pdf/chapter8.pdf (Sept 2004)
- For septic system by University of Minnesota Extension Service: www.extension.umn.edu/distribution/naturalresources/DD6651.html (Sept 2004)
- For pest control and pesticide safety:
<http://pep.wsu.edu/psp/scripts/documents.asp?qryType=new>, and
<http://scholar.lib.vt.edu/ejournals/JPSE/v5/v5hipkinsra2.pdf> (Sept 2004)
- For HVAC:
www.healthgoods.com/Education/Healthy_Home_Information/Space_Heating_and_Cooling/sizing_heat_and_ac.htm (Sept 2004)

6.2 OPTIONAL ITEMS TO INCLUDE IN THE HOME MANUAL (CHOOSE AT LEAST FIVE)

- List of local service providers that focus on regularly scheduled maintenance and proper operation of equipment and the structure (sealants, caulks, gutter and downspout system; shower/tub surrounds, irrigation systems, etc.).
- Photo record of framing showing utilities installed. Photos should be taken prior to installing insulation, clearly marked, and provided in homeowner's manual.
- List of the Green Building Guideline items that are included in the home.
- User-friendly maintenance checklist.
- Instructions for proper handling and disposal of hazardous materials.
- Information on organic pest control, fertilizers, de-icers, and environmental cleaning products.
- Maintenance instructions for native or low-water landscape.
- Information on how to keep a home's relative humidity in the range of 30% to 60%.
- Information about checking crawl space for termite tubes periodically.
- Instructions for keeping gutters clean. Information should note that downspouts should divert water at least five feet away from foundation.

Intent:

Provide further information about maintenance and operation of a green home and the surrounding site.

Information / How to Implement:

Provide above information in the homeowner's manual.

Resources:

- Home*a*Syst, An Environmental Risk-Assessment Guide for the Home, Healthy Home Tool, available at www.uwex.edu/homeasyst

- Local Green Building Checklist or other documents
- EPA document: www.epa.gov/epaoswer/non-hw/household/hhw.htm
- Check with the local or state environmental or solid-waste agency to see if there is a hazardous waste drop-off day. Local recycling information may cover hazardous wastes. The county or state may have Cooperative Extension fact sheets geared toward your municipality (see, for example, www.epa.gov/grtlakes/seahome/housewaste/src/open.htm).
- Local Cooperative Extension office should have printed information. Also, organic-based lawn services, such as NaturaLawn, usually have printed information.
- County or state Cooperative Extension publications
- Cooperative Extension publications for information about termite tubes, where to look for them, and what they look like. See, for example, www.uky.edu/Agriculture/Entomology/entfacts/struct/ef604.htm.

6.3 PROVIDE EDUCATION TO OWNERS/OCCUPANTS IN THE USE AND CARE OF THEIR DWELLINGS

A. Instruct homeowners/occupants about the building's goals and strategies and occupant impacts on costs of operating the building. Provide training to owners/occupants for all control systems in the house.

Intent:

During the walk-through, demonstrate how to control all the mechanical systems in the home. Demonstrate how to use all controls such as thermostats, lighting controls, and fan controls.

Resources:

- National Association of Home Builders, *Your New Home and How to Take Care of It*. Washington, DC: BuilderBooks, 2001, 60 pages Provide homeowners tips on maintenance to help keep their new home performing at its peak. In the back there are pages on which to note maintenance dates and remarks.
- www.builderbooks.com, 800-223-2665
- Manuals from manufacturers for reference.

6.4 SOLID WASTE

A. Encourage homeowners/occupants to recycle by providing built-in space in the home's design for recycling containers.

Intent:

Make it convenient to recycle.

Information / How to Implement:

Include a recycling center in or near the kitchen under the sink, in an island near the sink, or in a pantry. Credit is also given in this line item for an in-counter compost bin.

Hardware is available for recycling bins to rest on slides. Most under-sink recycling systems can fit two bins under one side of the sink, allowing plenty of room for other typical under-sink items.

Resources:

- www.toolbase.org/tertiaryT.asp?TrackID=&CategoryID=1280&DocumentID=2001

6.5 INNOVATIVE OPTIONS

Information will be added in Version 2.

7.1 PRODUCTS

7.1.1 Manufacturers' operations and business practices include environmental management system concepts (the product line, plant, or company must be ISO 14001 certified).

Intent:

Use products that come from organizations that have taken the time and resources to create an environmental management system (EMS) that conforms to the ISO 14001 standard.

Information / How to Implement:

See Resources section.

Resources:

- U.S. EPA Position Statement on Environmental Management Systems (EMS), www.mswg.org/USEPAPS/EMSpasState.pdf

7.1.2 Choose low- or no-VOC indoor paints. VOC concentrations (grams/liter) of interior paints should be equal to or less than those specified by the EPA's Environmentally Preferable Purchasing Program as follows:

- A. Interior latex coatings: Flat: 100 grams/liter
- B. Non-flat: 150 grams/liter
- C. Interior oil-based paints: 380 grams/liter

Intent:

Reduce the amount of volatile organic compounds (VOCs) released to the outdoors and to reduce the formation of ground-level ozone.

Information / How to Implement:

VOC content of paints is categorized under Global Impacts rather than Indoor Environmental Quality because, once a homeowner moves into a new home, the vast majority of VOCs in paints have been released to the atmosphere and are thus not a significant impact on indoor environmental quality.

Although emissions of VOCs from paints can negatively affect indoor air, the half-life of VOCs in paints is usually shorter than the time between painting and homeowner occupancy. For example, paints cure and finish off-gassing in approximately four days; a home buyer typically occupies a home two to four weeks after painting.

Although the builder's paint isn't a big indoor pollutant, homeowners can be informed about the use of low-VOC-emitting paints when repainting the home in the future. There are paints certified as low-VOC emitting that are certified through GREENGUARD—an independent air-quality certification organization.

Note that low-VOC-content paints are not the same as low-VOC-emitting paints. The U.S. EPA established low-VOC-content standards based on a set of ozone-forming chemicals; these standards do not take into account the many other potentially hazardous chemicals found in indoor paint.

Low-VOC-content paints are widely available; by choosing them you contribute to a healthier environment. Check the label on the paint can for the VOC content.

**Resources:**

- Green Seal certifies low-content paints: www.greenseal.org/certproducts.htm#paints
- The GREENGUARD Environmental Institute (GEI) provides a guide to third-party-certified low-VOC-emitting interior products and building materials, www.greenguard.org
- Master Painters Institute, www.paintinfo.com
- National Paints and Coatings Association (NPCA), www.paint.org
- EPA's Environmentally Preferable Purchasing Guide, www.epa.gov/oppt/epp/documents/pfs.htm (Sept 2004)

7.1.3 Use low-VOC sealants. VOC concentrations for construction adhesives and sealants should meet the limits specified in the California Air Resources Board Regulation for Reducing Volatile Organic Compound Emissions from Consumer Products as outlined below.

- A. Construction adhesives: the greater of 15% by weight or 200 grams/liter
- B. Sealants and caulks: the greater of 4% by weight or 60 grams/liter
- C. Contact adhesives: the greater of 80% by weight or 650 grams/liter

Intent:

Use low-VOC sealants to reduce potentially harmful VOCs from being emitted into the environment.

Information / How to Implement:

Note that, like low-VOC-content paints, low-VOC-content sealants are not the same as low-VOC-emissions. The California Air and Resources Board created low-VOC-content standards based on a set of ozone-causing chemicals. Also, VOC content does not directly equate to VOC emissions. In addition, VOC emission rates and times are greatly affected by temperature, humidity, age, and other factors.

Resources:

- www.arb.ca.gov/consprod/consprod.htm
- California Air Resources Board, www.arb.ca.gov/consprod/regs/Cpreg.doc (Sept 2004)

7.2 INNOVATIVE OPTIONS**7.2.1 Builder's operations and business practices include environmental management system concepts (the builder must be ISO 14001 certified)****Intent:**

Institutionalize and consistently apply the concept of incorporating environmental considerations into all phases of the company's operations.

Information / How to Implement:

At the time this document was created, there was only one ISO 14001 certified builder in the United States: Skanska USA.

You may be familiar with the 9000 series of international standards regarding quality management systems (QMS). As a continuation of this standardization process, the ISO 14000 series of international standards have been developed for environmental management systems (EMS).

In September 1996, the International Organization for Standardization (ISO) finalized the ISO 14001 standard for environmental management systems.

Similar to the QMS implemented for ISO 9001, the ISO14001 requires implementation of an EMS in accordance with defined, internationally recognized standards as set forth in the ISO14001 specification. The standard specifies requirements for establishing an environmental policy, determining environmental aspects and impacts of products/activities/services, planning environmental objectives and measurable targets, implementation and operation of programs to meet objectives and targets, checking and corrective action, and management review.

ISO14001 standards require a company to document and make this policy available to the public. In addition, the company must review the environmental aspects and impacts of products and then create and implement procedures to reduce them. The process of creating an EMS can help a company better understand how it affects the environment through all of its business processes.

Resources:

- Skanska USA's EMS information can be found at its website under Management Systems, www.skanska.com/
- The ISO 14001 Information Center provides information on the EMS at <http://www.iso14000.com>.

1.0 IDENTIFY GOALS WITH YOUR TEAM

Establish a knowledgeable team, and communicate in writing.

Intent:

One of the earliest challenges for a builder in developing a green lot is assembling an effective team to help implement best green practices throughout the process. Those involved in the development phase must understand the mission of the site, what it means to be a green lot, and why green practices should be followed. Once this baseline is established, coordination and communication with and among the various team members are essential to successful development.

Information / How to Implement:

Before ground is broken, all parties involved in lot development (the team) should understand that the lot will be developed as a green site. Team members can include staff, site superintendents, utilities, excavators, landscape architects, wildlife biologists, ecologists, and arborists. Once the green intent of the builder is communicated to the lot development team, the builder should work with the team throughout the development process to identify and delegate responsibilities of team members, as well as facilitate coordination between the members to achieve best green practices.

Resources:

- American Society of Consulting Arborists, www.asca-consultants.org/why.html
- American Society of Landscape Architects, www.asla.org/members/pigroups.cfm
- International Society of Arboriculture, www.isa-arbor.com/home.asp
- Society of American Foresters, www.safnet.org/certifiedforester
- The Ecological Society of America, www.esa.org

Establish a green development mission statement.

Intent:

Communicate relevant, streamlined green goals into the field to ensure that they are put into practice

Information / How to Implement:

Post the mission statement for all project personnel to see.

Resources:

Information will be added in Version 2.

Identify goals and objectives.

Intent:

Those involved in the development phase must understand the site's goals and objectives, what it means to be a green development, and why they should follow green practices.

Information / How to Implement:

Information will be added in Version 2.

Resources:

Information will be added in Version 2.

Identify team member roles and how they relate to various phases of development.

Intent:

Before ground is broken, all parties involved in lot development (the team) should understand that the lot will be developed as a green site.

Information / How to Implement:

Examples of possible team members include staff, site superintendents, utilities, excavators, landscape architects, wildlife biologists, ecologists, and arborists.

Resources:

Information will be added in Version 2.

Provide training to onsite supervisors and team members on the green development practices that will be instituted onsite.

Intent:

The noblest intentions pursued in designing a site are practically achieved through onsite supervision during the lot development phase. A qualified member(s) of the builder's team should be onsite as these activities progress to ensure that each objective is achieved according to targeted green lot specifications.

Information / How to Implement:

Information will be added in Version 2.

Resources:

Information will be added in Version 2.

Create a checklist to be completed onsite that contains only those targeted green development practices that will be implemented in the project.

Intent:

A qualified member(s) of the builder's team should be onsite as these activities progress to ensure that each objective is achieved according to targeted green lot specifications. A checklist will facilitate the process of tracking progress.

Information / How to Implement:

Information will be added in Version 2.

Resources:

Information will be added in Version 2.

2.0 SELECT THE SITE

Select the site to minimize environmental impact.

Avoid environmentally sensitive areas as identified through site footprinting process or third party.

Intent:

Thoughtful site selection can be the first step in building a green home. By avoiding environmentally sensitive areas, a

builder can help preserve land that might function as a wildlife corridor, recreational open space, or habitat sanctuary. If a site is selected that at any time has been identified as an environmentally sensitive area, no credit will be given for this line item, regardless of the site's classification at the time of construction.

Information / How to Implement:

“Sensitive areas” may be identified within a comprehensive plan, by a wetland institute, or by the local jurisdiction. Other excellent sources of detailed environmental information about a site are professionals such as arborists, landscape architects, ecologists, and wildlife biologists. These experts can provide assistance in identifying a potential site's natural resources and environmentally sensitive areas.

Resources:

- American Society of Consulting Arborists, www.asca-consultants.org/why.html
- American Society of Landscape Architects, www.asla.org/members/pigroups.cfm
- International Society of Arboriculture, www.isa-arbor.com/home.asp
- Society of American Foresters, www.safnet.org/certifiedforester
- The Ecological Society of America, www.esa.org
- Choose an EPA-recognized Brownfield.

Choose an infill site.

Intent:

Remediation of a brownfield results in the environmental restoration of a polluted site, a transformation that makes an abandoned site habitable. Like greyfield and infill development, brownfield development provides an efficient use of land and infrastructure while allowing for the preservation of open space and wildlife habitat in the midst of growth.

Information / How to Implement:

The U.S. Environmental Protection Agency (EPA) characterizes brownfields as “real property, the expansion, redevelopment, or reuse of which may be complicated by the presence or potential presence of a hazardous substance, pollutant, or contaminant.” The EPA estimates that there are 450,000 brownfield sites around the country. Grants, loans, and training are available through the EPA's Brownfield Initiative to assist builders and developers in the remediation and development of Brownfield sites.

Resources:

- U.S. EPA, *Brownfields Cleanup and Redevelopment*: www.epa.gov/Brownfields/index.html
- U.S. EPA has introduced two Web-based tools to give the public additional access to information about brownfield properties and cleanup efforts. The tools allow residents to locate brownfields and provide access to information about cleanup grants—www.epa.gov/Brownfields/bfwhere.htm

Choose a Greyfield site.

Intent:

Redevelopment of a greyfield site can provide an efficient use of land and infrastructure. Greyfield redevelopment allows for the preservation of open space and wildlife habitat in the midst of growth.

Information / How to Implement:

Within these guidelines, a greyfield is defined as “any site previously developed with at least 50% of the surface area covered with impervious material.” The development of a greyfield site can be daunting, but local or national incentives

may exist to reward builders who go through the process. Incentives may include the elimination of development-related fees, contribution from the local government in the development of offsite improvements, and tax breaks. For more information, see Resources.

Resources:

- Congress for the New Urbanism, www.cnu.org
- Urban Land Institute, www.uli.org
- American Planning Association, www.planning.org
- International Council of Shopping Centers, www.icsc.org
- Congress for the New Urbanism and PricewaterhouseCoopers, *Greyfields into Goldfields: from falling shopping centers to great neighborhoods* (February 2001), www.cnu.org/cnu_reports/Executive_summary.pdf
- Congress for the New Urbanism and PricewaterhouseCoopers, *Greyfield Regional Mall Study* (January 2001), www.cnu.org/cnu_reports/Greyfield_Feb_01.pdf

Choose an infill site.

Intent:

Building on an infill site can effectively conserve resources (e.g., infrastructure) and preserve open space that could be lost from “green field” development.

Information / How to Implement:

Infill areas are vacant or underutilized lots of land, served by existing physical installations such as roads, power lines, sewer and water, and other infrastructure.

Resources:

- Policy Link, Equitable Development Toolkit, Infill Incentives, www.policylink.org/EDTK/Infill
- Northeast-Midwest Institute and Congress for the New Urbanism, *Strategies for Successful Infill Development* (2001), www.nemw.org/infillbook.htm

3.0 DESIGN THE SITE

Minimize environmental impacts; protect, enhance, and restore the natural features and environmental quality of the site.

Conserve natural resources.

1. Complete a natural resources inventory that is used to drive/create the site plan.
2. Create a protection and maintenance plan for priority natural resources/areas during construction. (*See Section 4 for guidance in forming the plan.*)
3. Locate roads, buildings, and other built features to conserve high-priority vegetation.
4. Participate in a natural resources conservation program.

Intent:

Onsite natural resources concern features such as solar energy availability, flora, fauna, water, soil, and geological formations. A natural resources inventory should be completed to identify the site’s environmental attributes. A builder can identify high-priority resources for conservation (e.g., trees, waterways, snags, micro-habitats) and plan for the conservation of those resources during each stage of site development.

Information / How To Implement:

On complex sites, a natural resources inventory may be performed by a qualified professional such as an arborist, wildlife biologist, or landscape architect. Simpler sites, such as previously developed sites or farmland, might be adequately inventoried by knowledgeable but less qualified individuals. Whoever ultimately conducts the inventory should be able to discern invasive from regionally appropriate vegetation, understand how to site a house to take advantage of solar energy, be able to identify areas important to wildlife habitat, and understand how natural features can be used in managing storm water onsite.

A protection and maintenance plan should be drafted to detail how resources identified through the inventory will be protected throughout development. Section 4 of this module provides details on how to protect existing onsite vegetation and minimize soil disturbance and erosion through installation of fencing, identification of specified washout and material storage areas, laying of mulch to reduce soil compaction, and other means. In addition to protecting priority areas from invasive species intrusion during development, a maintenance plan should be created to ensure that priority vegetation survives development. Within the maintenance plan, include plans and information on fertilizing and watering trees as needed before, during, and after development.

One way to verify that the plan is implemented as planned is to create construction documents that explain how to implement the plan during construction.

Resources:

- American Society of Consulting Arborists, www.asca-consultants.org/why.html
- American Society of Landscape Architects, www.asla.org/members/pigroups.cfm
- International Society of Arboriculture, www.isa-arbor.com/home.asp
- Society of American Foresters, www.safnet.org/certifiedforester

Orient streets and configure lots to allow for the majority of homes to optimize solar potential (see the Energy Efficiency module for guidance on solar resource optimization).**Intent:**

Thoughtful orientation of a home can maximize solar heating potential in the heating season and minimize solar gains in the cooling season. By reducing non-renewable energy needs, orienting a home to optimize the solar resource reduces the life-cycle pollution caused by a home.

Information / How to Implement:

A builder should consider such issues such as slope, storm water management, local solar angles, and high-priority vegetation in determining the optimum site for each home. The final decision in siting a home will generally involve a compromise between these many factors.

Resources:

See Section 3.4 of this User Guide for resources.

Minimize slope disturbance.

1. Limit development footprint on steep slopes (slopes greater than or equal to 25%).
2. Complete a hydrological/soil stability study for steep slopes, and use this study to guide the design of all structures onsite.
3. Align roads with natural topography to minimize grade to reduce cut and fill.
4. Reduce long-term erosion effects through the design and implementation of terracing, retaining walls, and re-stabilization techniques.

Intent:

Leaving a slope undisturbed when siting a home reduces the chances of disturbing natural hydrological drainage and causing long- and short-term erosion, thereby reducing the potential to pollute water sources and damage local ecology.

Information / How to Implement:

Within these guidelines, steep slopes are defined as being greater than or equal to 25%. Note: Points should be awarded only if there are developable steep slopes in the area.

Reducing cut and fill practices can prevent unnecessary stripping of vegetation and loss of soils and reduce the need for additional resources to be brought in from offsite.

Resources:

- Prince George’s County, Maryland, Department of Environmental Resources, *Low-Impact Development Design Strategies: An Integrated Design Approach* (EPA 841-B-00-003) (Largo, MD: June 1999), www.epa.gov/owow/nps/lid/lidnatl.pdf

Minimize soil disturbance and erosion.

1. Phase development in order to minimize exposed soils.
2. Use alternative means to install utilities, such as tunneling instead of trenching. Use smaller equipment, shared trenches or easements, and place utilities under streets instead of yards.

Intent:

Sediment and pollutants contained in the sediment are recognized as a reason that water bodies do not meet their intended uses. Exposed soils should be minimized to reduce erosion, promote water quality, and reduce damage caused to native vegetation. Heavy equipment and excessive digging can result in compaction or loss of topsoil along with the introduction of invasive and problematic flora. Minimizing soil disturbance and erosion can both reduce stressors on downstream water bodies and save valuable topsoil for the site.

Information / How to Implement:

NAHB’s *Storm Water Permitting: A Guide for Builders and Developers* contains information about the federal Phase I and II storm water permitting program and the equivalent requirements for state storm water permits (see Resources section). *Storm Water Permitting* also contains technical information, including recommendations for use and cost estimates, on over 50 of the most commonly used best management practices; sample storm water pollution prevention plans; and tips on compliance, including how to handle visits from inspectors.

Methods for preventing erosion include silt fences, sediment traps, vegetated buffer areas, and mulching. More permanent solutions include biomechanical devices such as swales and vegetated buffers. Another highly effective, environmentally responsible method to prevent erosion is to use compost filter berms, compost erosion socks, and/or surface application of compost erosion control. The compost should be from organic sources like bioshields, yard waste, and wood chips. Turf and plant material—which help to facilitate the reestablishment of a natural environment—are established more quickly when organic compost is used.

Resources:

- National Association of Home Builders (NAHB), *Storm Water Permitting: A Guide for Builders and Developers*, 2005, store.builderbooks.com or 800-368-5242 x8163
- King County Department of Natural Resources, King County, Washington *Surface Water Design Manual Appendix D: Erosion and Sediment Control Standards* (Seattle: September 1998), <ftp://ftp.metrokc.gov/ddes/acrobat/esa/kcswdm-d.pdf>

- Dr. James R. Fazio, National Arbor Day Foundation, *Trenching and Tunneling: A Pocket Guide for Qualified Utility Workers* (Nebraska City, Nebraska: 1998), www.arborday.org/shopping/merchandise/merchdetail.cfm?id=62

Manage storm water properly.

1. Direct storm water to a locally approved regional storm water management and treatment facility that has been designed to address water quality.
2. Preserve and utilize natural water and drainage features.
3. Develop and implement storm water management plans that minimize concentrated flows and seek to mimic natural hydrology.
4. Minimize impervious surfaces, and utilize permeable materials for
 - a. Parking areas
 - b. Walkways
5. Minimize street widths and rights-of-way as per recommendations in either local code or in Residential Streets, 3rd Edition:
 - a. No on-street parking: 18 feet
 - b. Parking on one side: 22 to 24 feet
 - c. Parking on both sides: 24 to 26 feet

Intent:

Percolation through soil is one of the most effective means for filtering pollutants carried by storm water. By using natural water and drainage features, minimizing impervious surfaces, and distributing storm water flows, builders can reduce harmful pollutants carried offsite while safely and effectively managing much of their storm water load onsite.

Information / How to Implement:

Use open space and natural systems such as vegetative swales, french drains, wetlands, dry wells, and rain gardens that promote water quality and infiltration.

Resources:

- The Practice of Low Impact Development, U.S. Department of Housing and Urban Development (HUD); www.huduser.org/publications/destech/lowimpactdevl.html
- Tom Schueler, Center for Watershed Protection, *Site Planning for Urban Stream Protection*, Ellicott City, MD, 1995, www.cwp.org/SPSP/TOC.htm
- Lisa Austin, Washington State Department of Ecology Water Quality Program, *Stormwater Management Manual for Western Washington* (Publication 99-12), September 2001, www.ecy.wa.gov/pubs/9912.pdf
- Betty Rushton, Southwest Florida Water Management District, *Low Impact Parking Lot Design Reduces Runoff and Pollutant Loads: Annual Report # 1.*, Brooksville, Florida, 1999

Where municipal sewage is not available, use an advanced wastewater system as an alternative to the conventional septic system and drain field. Examples include sand/media filters and aerobic treatment units.

Intent:

Refer to the Water Efficiency section of the User Guide for details on this topic.

Information / How to Implement:

Information will be added in Version 2.

Resources:

Information will be added in Version 2.

Devise landscape plans to limit water demand while preserving or enhancing the natural environment.

1. Formulate a plan to restore or enhance natural vegetation that is cleared during construction or development. Within this plan, phase landscaping to ensure denuded areas are quickly vegetated.
2. Select turf grass and other vegetation that are native or regionally appropriate species.
3. Limit turf areas of landscaped area, selecting native and regionally appropriate trees and vegetation in a way that complements the natural setting.
4. Group plants with similar watering needs (hydrozoning).
5. Specify planting of trees to increase site shading and moderate temperatures (see also Energy Efficiency Guideline 3.3.5.1 specifying siting of trees to reduce the energy consumption of the home).
6. Require onsite tree trimmings of regionally appropriate species to be used as protective mulch during construction or as a base for walking trails.
7. Establish an integrated pest management plan to minimize chemical use in pesticides and fertilizers.

Intent:

Landscaping water use accounts for approximately 50% of a home's total water needs. Conservation of this valuable resource through such techniques as hydrozoning, reducing turf area, and selecting regionally appropriate plants is a key component to responsible building. Thoughtful selection and placement of plants can also reduce heating/cooling loads of a home, provide habitat for native fauna, and minimize the heat-island effect of developments.

Information / How to Implement:

Select landscaping materials and vegetation to fit site conditions. Regionally appropriate plants are hardy plants that can withstand local water and temperature conditions such as freeze, heat, drought, and rain. Regionally appropriate plants will also not be overly prolific or invasive, and will be able to coexist with other native plants over time. Other benefits of landscaping with native plants: minimizes maintenance (reduces emissions of equipment); fosters wildlife habitat. See EPA's Mid-Atlantic Region Green Landscaping <http://www.epa.gov/reg3esd1/garden/what.htm> for more information.

When planning for the revegetation of a site, consider the multiple services that natural areas can provide: natural habitat, storm water processing, shading, windbreak, etc. Trees that shade the streets can keep a neighborhood cool while also increasing the neighborhood's attractiveness. Properly selected plants can be grouped to serve as a bioretention zone. Deciduous trees allow the sun's rays through in winter and provide shade in the summer. Evergreens can provide an effective windbreak. Careful selection and integration of trees and vegetation can reduce a developer's initial costs while providing value to a development/neighborhood later. When planting trees, several factors should be taken into account such as the value of shading (trees shading asphalt will mitigate a site's temperature more than trees shading landscaped areas), maintaining a safe distance from the house (especially in areas prone to natural disasters), ultimate tree size, etc.

Developers may wish to consider enforcing guidelines for the protection of onsite vegetation. Some developers even fine builders for damage to areas designated for protection.

If grinding and scattering cleared plants, care should be taken to grind only regionally appropriate plants. Grinding of invasive species can increase their propagation and result in the ultimate destruction of native species.

One of the best ways to reduce energy consumption is through passive solar design of a home—using orientation, overhangs, fenestration, etc. Landscaping to reduce energy consumption is only part of the whole effort.

It is good practice to limit the ratio of turf area to total landscaped area due to maintenance requirements of turf versus native plants and regionally appropriate vegetation. In some areas, there may be restrictions on the percentage of turf that the front yard must contain. Research has shown that homeowners are comfortable with having as little as 50% of the front yard composed of turf. Fewer regulations are imposed on turf-to-landscaping ratio in the backyard, so good gains might be made more easily there. For research on turf and landscape of front yards with native species, see Nassauer, Joan, 1995. Messy Ecosystems, Orderly Frames. *Landscape Journal*, 14 (2), 161-170.

In areas with low annual rainfall, one way to account for water usage is through the development and implementation of a water budget.

Resources:

- Center for Plant Conservation, www.mobot.org/CPC
- Lady Bird Johnson Wildflower Center, Native Plant Information Network National Suppliers Directory, www.wildflower2.org/NPIN/Suppliers/suppliers.html
- New England Wildflower Society, *Native Plant Societies of the United States and Canada*, www.newfs.org/nps.htm
- NAHB Research Center Inc., Onsite Grinding of Residential Construction Debris: The Indiana Grinder Pilot, February 1999

Maintain wildlife habitat.

1. Preserve open space as wildlife corridors where possible.
2. Submit evidence of wildlife habitat preservation and improvements to the green development guidelines' administrator for review.
3. Participate in a wildlife conservation program.

Intent:

As the frontier of home building continues to expand, sharing the land with wildlife becomes an increasing challenge to builders. Through individual initiative or participation in a wildlife conservation program, home builders can work to create a habitat where both wildlife and humans can thrive—whether in an urban, suburban, or rural setting.

Information / How to Implement:

Examples of programs: USDA National Resources Conservation Service's Backyard Conservation Plan, the Audubon Cooperative Sanctuary System's Treasuring Home Initiative, or the National Wildlife Federation's Backyard Wildlife Habitat Program

Enhance quality of habitat, including food sources, diversity of habitat, and protective areas, through selective plantings and site design.

Leave snags (dead tree or portion that's left for habitat). Birdhouses.

Resources:

- Audubon International, *Audubon Cooperative Sanctuary System*, www.audubonintl.org/programs/acss. Audubon Cooperative Sanctuary System's Treasuring Home Initiative.
- Become a certified participant in the National Wildlife Federation's Backyard Wildlife Habitat Program. <https://secure.nwf.org/backyardwildlifehabitat/certify/page1.cfm>

Prepare operation and maintenance plan (manual) for transfer of common open spaces, utilities (storm water, wastewater), and environmental management.

Intent:

Green land use features often require ongoing maintenance so that they can continue to function as designed. Planning for such operations and maintenance prior to implementing the features is important and can help the long-term viability of such features.

Information / How to Implement:

Many manufacturers and distributors of green land use features and technologies also sell annual and/or long-term maintenance plans. Ask the manufacturers and/or distributors of the particular technology you're planning on implementing for such a service plan.

Resources:

Information will be added in Version 2.

Disassemble existing buildings, and reuse or recycle the building materials (deconstruction) instead of demolishing.

Intent:

See the Resource Efficiency section for details on this topic.

Information / How to Implement:

Information will be added in Version 2.

Resources:

Information will be added in Version 2.

4.0 DEVELOP THE SITE

Minimize environmental intrusion during onsite construction.

Provide onsite supervision and coordination during clearing, grading, trenching, paving, and installation of utilities to ensure that targeted green development practices are implemented.

Intent:

The noblest intentions when designing a green site are practically achieved through onsite supervision during the lot development phase. A qualified member(s) of the builder's team should be onsite as these activities progress to ensure that each objective is achieved according to targeted green lot specifications.

Information / How to Implement:

The information for this line item should link to the plans and any documents produced in line item 1.3.5.

Resources:

Information will be added in Version 2.

Conserve existing onsite vegetation.

1. Provide basic training in tree and other natural resource protection to onsite supervisor.
2. Minimize disturbance of and damage to trees and other vegetation designated for protection through installation of fencing and avoidance of trenching, significant changes in grade, and compaction of soil and critical root zones.

3. Prepare designated existing trees and vegetation for the impacts of construction through pruning, root pruning, fertilizing, and watering.
4. Improve the soil with organic amendments and mulch.

Intent:

After a builder has identified (during the planning stage) the existing vegetation that will be conserved onsite, practical steps must be taken during the development stage to achieve the intended conservation. Such steps include pre-development preparation of the vegetation and protection of the foliage, soil, and root system of designated vegetation.

Information / How to Implement:

See Resources section.

Resources:

- National Arbor Foundation, *Building With Trees*, www.arborday.org/programs/Buildingwithtrees/index.cfm
- Phillip A. Pratt and Michael W. Schnelle, Oklahoma State University, Oklahoma Cooperative Extension Service, *Site Disturbance and Tree Decline* (OSU Extension Facts F-6429), September 2003, <http://osuextra.com/pdfs/F-6429web.pdf>

Minimize onsite soil disturbance and erosion.

1. Demarcate limits of clearing and grading.
2. Create construction “no disturbance” zones using fencing or flagging to protect vegetation and sensitive areas from construction vehicles, material storage, and washout.
3. Install and maintain sediment and erosion controls.
4. Stockpile and cover good soil for later use.
5. Reduce soil compaction from construction equipment by laying mulch, chipped wood, or plywood sheets.
6. Stabilize disturbed areas within the 14-day period recommended by EPA.

Intent:

This guideline seeks to ensure the field implementation of conservation plans. Each measure identifies a practical way to foster water quality and conserve onsite ecological habitat through reducing soil disturbance and erosion.

Information / How to Implement:

Soil stabilization may be temporary or permanent.

Keep in mind that while the use of stockpiled onsite soil is a preferred method, excavation, stockpiling, grinding, and screening destroy the ecological microsystem of the soil. Rejuvenation of the unimproved soil to its original form will take several years. To offset this phenomenon, the incorporation of compost and sand is an effective method for more rapidly rebuilding the structure and ecosystem of the topsoil and allowing turf and plants to establish more quickly. As indicated above, compost is recommended for this purpose.

When additional soil must be brought in, there are environmental advantages of using industrial by-products as ingredients in topsoil including foundry sand, biosolids compost, and other EPA-approved by-products. In addition to keeping these materials out of community landfills, processing techniques produce superior topsoil.

The use of organic mulch is an excellent way to conserve water in landscape beds and build soil quality. Ideally, use mulch that results from onsite recycling efforts such as yard waste, processed pallets, and other clean wood from construction waste.

Resources:

- King County Department of Natural Resources, King County, Washington *Surface Water Design Manual Appendix D: Erosion and Sediment Control Standards* (Seattle: September 1998), <ftp://ftp.metrokc.gov/ddes/acrobat/esa/kcswdm-d.pdf>

5.0 INNOVATIVE OPTIONS

Seek to obtain waivers or variances from local development regulations to enhance green building.

Cluster development to preserve meaningful open space.

Intent:

Preserve meaningful open space, and reduce infrastructure and long-term maintenance costs.

Information / How to Implement:

During the past 50 years, a steady migration from urban to suburban areas and into the countryside has constituted a significant trend throughout much of the United States. In response to this phenomenon, planners, developers, and elected officials have created a number of tools designed to balance growth with the preservation of community environmental and financial assets. One tool that has received an increasing amount of attention lately is cluster development. This approach may be termed open-space development, conservation development, hamlet style, farm village, or other unique names coined by proponents and developers. Regardless of the title used to describe it, cluster development is an important tool community planners should consider as they look to the future. The purpose of this fact sheet is to describe cluster development, its history, potential, and limitations.

Resources:

- U.S. Environmental Protection Agency, Development, Community, and Environment Division, *Our Built and Natural Environments* (EPA 231-R-01-002) (Washington, DC: 2001), www.epa.gov/smartgrowth/pdf/built.pdf
- Urban Land Institute, www.uli.org/DK/index.cfm?CFID=526893&CFTOKEN=67483350

Reduce street widths.

Intent:

Reduce the amount of impervious surface and storm water runoff in the development.

Information / How to Implement:

Street widths have the largest impact on runoff and on costs. Unfortunately, most communities have ordinances requiring excessively wide streets. Developers may be able to negotiate changes for a particular development but will likely have to seek changes to local land development standards to change street-width requirements more generally. The publication, *Proposed Model Land Development Standards and Accompanying Model State Enabling Legislation* (HUD and NAHB Research Center, 1993), includes recommendations for minimum street widths that recognize the cost and environmental benefits of narrower versus wider streets (see below) and other cost-effective development strategies. It also includes recommendations for turnarounds, another location where the pavement area can be reduced.

Recommendations for Minimum Street Widths

Widths of Traveled Way

Minimum Width of Traveled Way (ft.)

Street Type	Both On- and Off-Street Parking (1)	One-Way Street (2)
Major Collector	20 (3)	10
Collector	36 (4)	26
Subcollector	26–28 (4, 5)	26
Access	18–22 (5)	18

Where no off-street parking is provided, the minimum width of traveled way for collector streets shall be 36 feet, and 34 feet for subcollector and access streets (two 9- or 10-foot travel lanes and two 8-foot parking lanes). Major collectors do not typically accommodate on-street parking. Access street width can be reduced to 26 feet if parking needs are met on one side of the street and restricted to that side only.

Where on-street parking is not permitted, the one-way street width may be reduced to 10 feet.

Parking is not allowed on major collector streets. Travel lanes may be added in accordance with traffic requirements.

Width can be reduced to 20 feet if on-street parking is not permitted.

Minimum street width shall be selected by taking into consideration the size of fire and emergency equipment that will serve the development.

Resources:

- Better Site Design Fact Sheet: Narrower Residential Streets, www.stormwatercenter.net/Assorted%20Fact%20Sheets/Tool4_Site_Design/narrow_streets.htm

Install an advanced wastewater treatment system.

Intent:

See the Water Efficiency section of the User Guide for more details on this topic.

Information / How to Implement:

Information will be added in Version 2.

Resources:

Information will be added in Version 2.

Install an advanced storm water treatment system.

Intent:

Percolation through soil is one of the most effective means for filtering pollutants carried by storm water. By using natural water and drainage features, minimizing impervious surfaces, and distributing storm water flows, builders can reduce harmful pollutants carried offsite while safely and effectively managing much of their storm water load onsite.

Information / How to Implement:

This line item would be over and above what is done for line item 1.3.5. Use open space and natural systems such as vegetative swales, french drains, wetlands, dry wells, and rain gardens that promote water quality and infiltration.

Resources:

- *The Practice of Low Impact Development*, U.S. Department of Housing and Urban Development (HUD); www.huduser.org/publications/destech/lowimpactdevl.html
- Tom Schueler, Center for Watershed Protection, *Site Planning for Urban Stream Protection* (Ellicott City, MD: 1995), www.cwp.org/SPSP/TOC.htm
- Lisa Austin, Washington State Department of Ecology Water Quality Program, *Stormwater Management Manual for Western Washington* (Publication 99-12) (September 2001), <http://www.ecy.wa.gov/pubs/9912.pdf>
- Betty Rushton, Southwest Florida Water Management District, *Low Impact Parking Lot Design Reduces Runoff and Pollutant Loads: Annual Report # 1*. (Brooksville, Florida: 1999)

Institute wildlife habitat measures.

Intent:

As the frontier of home building continues to expand, sharing the land with wildlife becomes an increasing challenge to builders. Through individual initiative or participation in a wildlife conservation program, home builders can work to create a habitat where both wildlife and humans can thrive—whether in an urban, suburban, or rural setting.

Information / How to Implement:

Examples of programs include the USDA National Resources Conservation Services Backyard Conservation Plan, the Audubon Cooperative Sanctuary System,s Treasuring Home Initiative, and the National Wildlife Federations Backyard Wildlife Habitat Program.

Enhance quality of habitat, including food sources, diversity of habitat, and protective areas, through selective plantings and site design.

Leave snags (dead tree or portion thats left for habitat).

Resources:

- Audubon International, *Audubon Cooperative Sanctuary System*, www.audubonintl.org/programs/acss. Audubon Cooperative Sanctuary System,s Treasuring Home Initiative.
- Become a certified participant in the National Wildlife Federation,s Backyard Wildlife Habitat Program. <https://secure.nwf.org/backyardwildlifehabitat/certify/page1.cfm>

Minimize grading.

Intent:

Excessive grading can disturb a site's natural drainage, vegetation, and ecological habitat. If topsoil removed during grading is not replaced, the health of the site's future ecological system may be compromised as well.

Information / How to Implement:

Information will be added in Version 2.

Resources:

Information will be added in Version 2.

Share driveways or parking

Intent:

Sharing driveways or parking can reduce the amount of impervious material on a lot, thereby decreasing storm water and pollution runoff.

Information / How to Implement:

Information will be added in Version 2.

Resources:

Information will be added in Version 2.

Other (specify).

Information will be added in Version 2.